

Toll Free No. 1800 890 9115

# India's Largest Shop for Material Management



## Protect Your Products



Packing leather bags in Giant Crate



Serving pastries in Insulated Food Carriers



Automobile components in Customized Partition Crates

## Improve Your Storage Efficiency



Multi-tier Shelving Storage Systems in an E-commerce warehouse



Automotive spares in reusable cartons on Palletized Heavy Duty Racks



Semi-automatic Shuttle Racking System in a bottling plant

## Increase Your Labour Productivity



Electric Stacker moving pallet from the rack



Combilift Multi-directional Forklift shifting long load in narrow aisle



Aisle Master Articulated Forklift picking material in narrow aisle

40 Regional Offices With 37 Depots Across India To Directly Service You

400+ Sales & Service Staff To Directly Work With You

**A One Stop Shop For Material Handling Solutions**

# CONTENTS



## 05 PLASTIC CRATES

- 06. Series Crates (300 X 200)
- 07. Series Crates (400 X 300)
- 08. Series Crates (500 X 325)
- 09. Series Crates (540 X 360)
- 10. Series Crates (600 X 400)
- 11. Series Crates (600 X 400 DW)
- 12. Automation Crates/ Sorters Crates
- 13. Jumbo Crates
- 14. Giant Crates
- 15. Conductive Crates
- 16. Accessories
- 17. Roto Moulded Crates
- 19. Specialized Crates
- 20. Plastic Milk Cans
- 21. Shopping Basket



## 48 PLASTIC PALLETS

- 48. Pallet Selection Chart
- 50. Model - AP 1210
- 51. Model - SP 1210
- 52. Model - AP 0606
- 53. Model - DP 1311
- 54. Other Injection Moulded Pallets
- 55. Other Misc. Pallets
- 57. Roto Moulded Pallets
- 58. Pallet Design Classics
- 59. Spill Pallets & Drum Pallets
- 60. Kit Crates



## 22 MAINTENANCE PRODUCTS

- 23. Front Partly Open(FPO)Crates
- 24. Metal Stands For FPO Crates
- 25. Max Crates
- 27. Tool Storage Cabinets
- 28. Modular Crates & Racks



## 29 RETURNABLES

- 30-32. Space Saving Crates
- 33. PP Corrugated Crates & Textile Packaging Solutions
- 34. Pallet Sleeve Boxes
- 35. Vacuum Formed Products
- 36. Roto Molded Palletised Crate



## 61-62 J.R. M.H.E. & METALLIC CAGES

- 61. Rolling Equipments, Trolleys
- 62. Wiremesh Cages, Roll cages, IBC's



## 37 Vaccine Cold boxes and carriers

- 37-44. Vaccine Cold boxes and carriers



## 45 Continuous Inkjet Printer

- 45-47. Continuous Inkjet Printer



## 63-79 M.H.E.

- 63. Selection Chart
- 66. Manual Range
- 67. Electric Range
- 70. Work Platforms
- 71. Loading Equipment
- 72. Drum Handling Equipment
- 73. Forklift Range
- 75. Articulated Forklift
- 79. Hand free hand Wash Station

# CONTENTS



## 80 STORAGE SYSTEMS

- 81. Universal Storage Systems (USS)
- 83. Flexi USS (With Partition)
- 84. Long Span Shelving Systems (LSS)
- 85. Compactors
- 87. Pallet Storage Systems (PSS)
- 89. Mezzanine Storage Systems
- 91. Multi tier Storage Systems
- 93. Drive-in Storage Systems
- 95. AS / RS
- 97. Cantilever Storage Systems
- 99. Pallet Mover Systems
- 101. Kanban Storage Systems



## 102 AUTOMATED VERTICAL STORAGE & RETRIEVAL SYSTEMS

- 102. Hanel Leanlift
- 104. Hanel Rotomat



## 106 COLD CHAIN PRODUCTS

- 107. Ice Boxes
- 108. Fish Tubs
- 109. Storage Racks



## 110 FOOD SERVICE PRODUCTS

- 110 . Food Service Products
- 113 Hospitality Products



## 116 PRIMARY RIGID PACKAGING PRODUCT



## 117 WASTE MANAGEMENT PRODUCTS

- 118 Round Container
- 119 Roto Free Stand Litter Bins (RFLB)  
Wheeled Bins
- 120. Street Collection



## 121-122 ROAD SAFETY PRODUCTS

- 121. Perforated & Safety Barricades
- 122. Safety Barricades & Road Fences

# ABOUT US

**NILKAMAL LIMITED, a Rs. 2200 crores (US\$ 323 million) [(F.Y. 2018-19) as on 31st March 2019]** company is into manufacture of molded plastic material handling crates and furniture. We are a Public Limited company listed on the Bombay Stock Exchange. Supported by sales network of more than 400 sales personnel operating through over 40 regional offices and 37 warehouses across India. We are truly **A One Stop Shop For Material Handling Solutions.**

Our portfolio of products manufactured & marketed includes the following:

**Manufacturing strength – 9 Global scale factories across India, all ISO 9001:2008 Certified.**

- Plastic crates & pallets
- PP Corrugated Boxes
- Textile Partition Packaging for scratch sensitive products
- Storage systems in metal
- Exhaustive range of Material Handling Equipments
- Forklift Trucks & Warehousing Systems
- Very Narrow Aisle Forklift Trucks that maximize warehousing space from Aisle Master - the leading international brand of VNA trucks.
- Specialised forklift trucks for long loads and Multidirectional movement from CombiLift .
- VNA Man Up turret trucks for order picking in high density warehouses from Magaziner.
- Vacuum Lifting equipments from Vaculex
- Automated Vertical Storage & Retrieval Systems from Hanel, Germany
- Road Safety Products
- Insulated Boxes
- Insulated Fish Tubs
- Fruit ripening chambers and cold storage
- Floating fish cages
- Waste Bins – Mfg roto moulded & injection molded waste bins and marketing EN 840 Compliant Waste Bins well accepted across progressive civic bodies across India.

Apart from material handling, we are India's No 1 manufacturer of plastic chairs and plastic furniture. We have also successfully ventured in home décor retail segment with our own signature store chain across major Indian cities - @home, having over 19 stores each with an approximate area over 20,000 Sq ft per store. We have a joint venture with CAMBRO Mfg. Co. USA now for a significant presence in the Food & Beverage Service Business for the Hospitality Industry and count India's best Hotels and kitchen services amongst our established customers.

### Recognitions :

### Joint Ventures :

### Distributorships / Marketing Agents :

# MOULDED PLASTIC CRATES :

**Nilkamal** pioneered the use of moulded plastic crates in India and has remained industry leader in India. Innovation and a proactive approach to customer needs has led us to offer the widest range of moulded plastic crates in the Indian market, catering to practically every user segment and also creating some additional ones in the process. This section gives extensive information on our range of our Injection and Roto Moulded Plastic Crates – detailed lists of models and respective versions along with their dimensions that will make your buying choices easier .



Giant crates used in automotive battery assembly



Crates used in storage & handling



Roto moulded crates used in textile dyeing

# 300 X 200 SERIES CRATES

All Crates have built-in handles & are made from Food Grade H.D.P.E.



CC Version : Complete Closed



Used in Power Looms



CCF Version : Complete Closed  
With Flat Bottom



FPO Version : Front Partly Open



LID32000 With Locking Clips  
For 300 x 200 series crates

Model	Available Versions	Outer Dimensions (L x B X H in mm)	Inner Dimensions (L x B X H in mm)
32070	CC / CCF	300 x 200 x 70	265 x 165 x 60
32100	CC / CCF	300 x 200 x 100	265 x 165 x 95
32120	CC / CCF	300 x 200 x 120	265 x 165 x 115
32150	CC / CCF / FPO	300 x 200 x 150	265 x 165 x 145
32200	CC / C	300 x 200 x 200	265 x 165 x 195



# 400 X 300 SERIES CRATES

All Crates have built-in handles & are made from Food Grade H.D.P. E.



**CC Version : Complete Closed**



**CCC Version : Complete Closed With Criss cross Bottom**



**JBC Version: Jali Bottom Closed**



**CH Version: Closed with Handle**



**CCF Version : Complete Closed With Flat Bottom**



**JR Version: Jali (Perforated) Regular**

Model	Available Versions	Outer Dimensions (L x B X H in mm)	Inner Dimensions (L x B X H in mm)
43065	CC / CCF	400 x 300 x 65	365 x 265 x 60
43090	CC / CCF	400 x 300 x 90	365 x 265 x 85
43100	CC / CCF	400 x 300 x 100	365 x 265 x 95
43120	CC / CCC / CCF	400 x 300 x 120	365 x 265 x 115
43150	CC / CCF / JR	400 x 300 x 150	365 x 265 x 145
43175	CC / CCF / CH / CHF / JBC / JR	400 x 300 x 175	365 x 265 x 170
43200D	CC / CH	400 x 300 x 200	365 x 265 x 195
43220	CC / CCF / CH / CHF	400 x 300 x 220	365 x 265 x 215
43230	CC / CCC	400 x 300 x 230	365 x 265 x 225
43240	CC / CCC / CCF	400 x 300 x 240	365 x 265 x 235
43270	CC / CCF	400 x 300 x 270	365 x 265 x 265
43320	CC / CCF / CH / CHF	400 x 300 x 320	365 x 265 x 315



**LID43000 With Locking Clips**  
For 400 x 300 series crates



**LIDBOXWLC43GRY (Without Lid Clip)**  
410 (L) x 310 (W) x 40 (H) mm  
(With Lid Clip Also Available : LIDBOX43GRY)



**STACKING WITH LID**



# 500 X 325 SERIES CRATES



CC Version : Complete Closed



CH Version: Closed with Handle



CCF Version : Complete Closed With Flat Bottom



JBC Version: Jali Bottom Closed



JR Version: Jali (Perforated) Regular



FPO Version : Front Partly Open

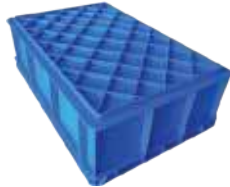

CCDD Version : Complete Closed with Deep Diamond bottom



Front



Bottom

CCSDW Version: Complete Closed Small Square Bottom Double Wall



JBCLW Version: Jali Bottom Closed Low Weight

Model	Available Versions	Outer Dimensions (L x B X H in mm)	Inner Dimensions (L x B X H in mm)
53100	CC / CCF / CH / CHF	500 X 325 X 100	465 X 290 X 90
53150	CC / CCF / CH / CHF / JBC / JR / FPO / CCDD / CHDD / JBCLW	500 X 325 X 150	465 X 290 X 140
53200	CC / CCF / CH / CHF / JBC / FPO	500 X 325 X 200	465 X 290 X 190
53250	CC / CCF / CH / CHF / JBC / FPO / CCDD / CHDD	500 X 325 X 250	465 X 290 X 240
53360	CC / CCF / CH / CHF / JBC / JR / CCDW	500 X 325 X 360	465 X 290 X 350



LID53000 With Locking Clips  
For 500 x 325 series crates



# 540 X 360 SERIES CRATES



**CC Version : Complete Closed**



**CH Version: Closed with Handle**



**JBC Version: Jali Bottom Closed**



**JR Version: Jali (Perforated) Regular**



**LID5436000 With Locking Clips**  
For 540 x 360 series crates



Model	Available Versions	Outer Dimensions (L x B X H in mm)	Inner Dimensions (L x B X H in mm)
5436205	CC / CCF / JR	540 X 360 X 205	510 X 328 X 195
5436275	CC / CCF / CH / CHF / JBC / JR	540 X 360 X 275	540 X 360 X 265
5436295	JR	540 X 360 X 295	540 X 360 X 285
5436300	CC / CCF / CH / CHF / JBC	540 X 360 X 300	540 X 360 X 290
5436340	CC / CCF / CH / CHF / JBC	540 X 360 X 340	540 X 360 X 330
5436400	CC / CCF / CH / CHF / JBC	540 X 360 X 400	540 X 360 X 390



# 600 X 400 SERIES CRATES



**CC Version : Complete Closed**



**CH Version : Closed With Handle**



**JBC Version : Jali Bottom Closed**



**JR Version : Jali (Perforated) Regular**



**CHDW Version :  
Closed with Handle With  
Double Wall**



**CCC Version :  
Complete Closed with Criss  
Cross Bottom**



**CCF Version :  
Complete Closed With  
Flat Bottom**



**WR Version : Without Ribs**



**JRFC Version :  
Jali Regular Foldable  
Crate**

**JBCNJ** : Jali Bottom Closed with New Jali • **CHFWR** : Closed with Handle & Flat Bottom Without Ribs • **FPO** : Front Partly Open • **LSO** : Long Side Open

Model	Available Versions	Outer Dimensions (L x B X H in mm)	Inner Dimensions (L x B X H in mm)
64080	CC / CCF / CCS / JBC / JR / JBF	600 X 400 X 80	565 X 365 X 75
64120	CC / CCC / CCF / CCS / CH / CHC / CHF / CHS / JBC / JBCHC / JBS / JR / JRHC / JRSJ / JBF	600 X 400 X 120	565 X 365 X 115
64150	CC / CCF / CCS / CH / CHF / JBC / JR	600 X 400 X 150	565 X 365 X 145
64160	CC / CCF / CCS / CH / CHF / CHS / JBC / JBS / JBF / JR	600 X 400 X 160	565 X 365 X 155
64175	CC / CCF / CH / CHF / JBCHC / JBCNJ / JBCNJHC	600 X 400 X 175	565 X 365 X 170
64200	CC / CCF / CH / CHF / JBC / JRFC	600 X 400 X 200	565 X 365 X 195
64220	CC / CCC / CCF / CH / CHF / JBC / JR / CCHW	600 X 400 X 220	565 X 365 X 215
64230	CCC / CCF / CHC	600 X 400 X 230	565 X 365 X 225
64240	CC / CCF / CH / CHF / JBC / CCHW	600 X 400 X 240	565 X 365 X 235
64280	CC / CCF / CH / CHF / JBC	600 X 400 X 280	565 X 365 X 275
64285	CC / CCF / CH / CHF / JBC / JR	600 X 400 X 285	565 X 365 X 280
64300	CC / CCF / CH / CHF / JBC	600 X 400 X 300	565 X 365 X 295
64320	CC / CCC / CCF / CCFWR / CHF / CHFWR / CH / JBC / JR	600 X 400 X 320	565 X 365 X 315
64340	CC / CCF	600 X 400 X 340	565 X 365 X 335
64350	CC / CCDW / CH / CHDW	600 X 400 X 350	565 X 365 X 345
64375	CC / CCF / CH / CHF / JBC / LSO	600 X 400 X 375	565 X 365 X 370
64400	CC / CCF / CH / CHF / JBC	600 X 400 X 400	565 X 365 X 395
64425	CC / CCC / CCF / CH / CHF / JBC	600 X 400 X 425	565 X 365 X 420
64450	CCC	600 X 400 X 450	565 X 365 X 445
64485	CC / CCF / CH / CHF / JBC / JR / FPO	600 X 400 X 485	565 X 365 X 480

# 600 X 400 SERIES CRATES (DW)



Model : CC64080 with dome handle



Model : JBC64120 with flat handle



Model : JR64120SJ with dome handle



Model : CH64175 with flat bottom



Model : CC64160 with small square bottom



Model : CC64175 with criss cross bottom



DW : Double Wall



D : Dome Handle

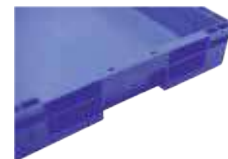

F : Flat Handle

VERSION	MODEL NO	DESCRIPTION	HANDLE	OUTER DIMENSIONS (L X B X H) IN MM.
64080	CCSD64080DW	Complete Closed Small Square Bottom & Dome Handle	DOME	620 X 400 X 80
	CCS64080DW	Complete Close Small Square Bottom	FLAT	600 X 400 X 80
	CCFD64080DW	Complete Closed Flat Bottom & Dome Handle	DOME	600 X 400 X 80
	CCF64080DW	Complete Closed Flat Bottom	FLAT	600 X 400 X 80
	CCC64080DW- always flat handle for criss cross stack	Complete Closed Criss Cross Bottom (with Flat Handle only)	FLAT	600 X 400 X 80
64120	CCSD64120DW	Complete Closed Small Square Bottom & Dome Handle	DOME	620 X 400 X 120
	CCS64120DW	Complete Closed Small Square Bottom	FLAT	620 X 400 X 120
	CCFD64120DW	Complete Closed Flat Bottom & Dome Handle	DOME	620 X 400 X 120
	CCF64120DW	Complete Closed Flat Bottom	FLAT	620 X 400 X 120
	JRS64120DWSJ	Jali Regular & Flat Handle	FLAT	620 X 400 X 120
	JRSD64120DWSJ	Jali Regular & Dome Handle	DOME	620 X 400 X 120
	JBCS64120DW	Jali Bottom Closed Small Square Bottom & Flat Handle	FLAT	620 X 400 X 120
	JBCSD64120DW	Jali Bottom Closed Small Square Bottom & Dome Handle	DOME	620 X 400 X 120
	CCC64120DW -always flat handle for criss cross stack	Complete Closed Criss Cross Bottom (with Flat Handle only)	FLAT	620 X 400 X 120
64160	CCS64160DW	Complete Closed Small Square Bottom & Flat Handle	FLAT	620 X 400 X 160
	CCFD64160DW	Complete Closed Flat Bottom & Dome Handle	DOME	620 X 400 X 160
	CCF64160DW	Complete Closed Flat Bottom	FLAT	620 X 400 X 160
	CCFD64160DW	Complete Closed Small Square Bottom & Dome Handle	DOME	620 X 400 X 160
	CCC64160DW	Complete Closed Criss Cross Bottom (Always Flat Handle)	FLAT	620 X 400 X 160
64175	CCSD64175DW	Complete Closed Small Square Bottom & Dome Handle	DOME	600 X 400 X 175
	CCS64175DW	Complete Closed Small Square & Flat Handle	FLAT	600 X 400 X 175
	CCFD64175DW	Complete Closed Flat Bottom & Dome Handle	DOME	600 X 400 X 175
	CCF64175DW	Complete Closed Flat Bottom & Flat Handle	FLAT	600 X 400 X 175
	CCC64175DW -always flat handle for criss cross stack	Complete Closed Criss Cross Bottom (with Flat Handle only)	FLAT	600 X 400 X 175

All Crates are available with criss cross / small square & flat bottoms except 64160 which is available with small square bottom

# AUTOMATION CRATES/ SORTERS CRATES



Available Version : 600x400  
Available height(in mm.) : 300/ 540



Available versions : CC / CH / CHF/ CHT (600X400/ 400X300)  
Available height(in mm.) : 180 / 325/ 350/ 400

## BAGGAGE TRAYS

These crates are specially designed Baggage Trays to hold mobiles, laptops, bags, purses etc. at checking points of hotels/malls/aiports.



Model : **RMC342560 (For Mobiles, Wallets etc.)**  
Outer Dimensions : **340 (L) X 250 (B) x 60 (H) mm.** ● Capacity : **10 kgs.**



Model : **RMC493580 (For Laptops, Purses etc.)**  
Outer Dimensions : **485 (L) X 353 (B) x 80 (H) mm.** ● Capacity : **25 kgs.**



Model : **RMC8157230 (For Baggage)**  
Outer Dimensions : **805 (L) X 570 (B) x 235 (H) mm.** Capacity : **25 kgs.**



Model : **RMC7853230 (For Baggage)**  
● Outer Dimensions : **790 (L) X 550 (B) x 218 (H) mm.** ● Capacity : **25 kgs.**  
● Inner Dimensions : **680 (L) X 465 (B) x 210 (H) mm.**

# JUMBO CRATES

These high capacity stackable crates made from food grade HDPE are ideal for a large variety of storage applications across industries. Commonly used in industries such as Fisheries, Bakery, Catering as well as Engineering. Nilkamal also offers the Double Wall Jumbo Crates for heavy duty usage in Fisheries. The double wall offers extra protection as well as withstands rigorous usage.



**CC Version : Complete Closed**



**CH Version : Closed with Handle**



**JBC Version : Jali Bottom Closed**  
(Also available **LW : Low Weight**)



**JR Version : Jali (Perforated) Regular**



**DW Version : Double Wall**



**LID6545000 With Locking Clips**

Model	Available Versions	Outer Dimensions (L x B X H in mm)	Inner Dimensions (L x B X H in mm)
<b>6545195</b>	CC / CH / JBC / JR	650 X 450 X 195	610 X 405 X 185
<b>6545205</b>	CC / CCF / CH / CHF / JBC / JR	650 X 450 X 205	610 X 405 X 195
<b>6545210</b>	CC / CH / JBC / JR	650 X 450 X 210	610 X 405 X 200
<b>6545315</b>	CC / CCF / CH / CHF / JBC / JR / DW / JBC LW / JBC NBLW JR NBLW	650 X 450 X 315	610 X 405 X 305
<b>6545480</b>	CC / CCF / CH / CHF / JBC / JR	650 X 450 X 480	610 X 405 X 470



# GIANT CRATES

Made from food grade HDPE, Nilkamal Giant Crates are stackable, easy to clean and free from maintenance and have a huge capacity of 163 litres. Ideal choice for fruits, flowers and vegetable transportation, Nilkamal Giant Crates also find application in various industries such as light engineering, textiles, garments and many others. Can also be fitted with wheels.



**CH Version : Closed with Handle (With wheels : Optional)**



**LID85000 : Roto Molded Lid for Giant Crates**



**CC Version : Complete Closed**



**JBC Version : Jali Bottom Closed**



**JR Version : Jali (Perforated) Regular**



**Model : 85425 Available Versions : CC / CH / JBC / JR / W •Outer Dimensions : (L x B X H in mm.) : 810 X 568 X 425 •Inner Dimensions : (L x B X H in mm.) : 763 X 521 X 410**

# CONDUCTIVE CRATES

**Nilkamal Conductive crates** are made from specially permanent blended raw material which prevents or dissipates electric charges. They are highly recommended for the industries which are handling and using highly sensitive electronics components. The excellent characteristics of the material are highly regarded in Electronics / Electrical / Mechanical Engg., Data Processing, Mining Ammunition & in explosive manufacturing industries. All types of packaging & handling equipment manufactured, gives the necessary protection, particularly for modern electronic components, complete modules and assembled printed circuit boards & other static sensitive devices (SSD). Nilkamal has a wide range of crates, PCB holders, PCB crates, Injection Molded crates, lids & FPO crates.

Basic Material : Polypropylene Copolymer (PPCP) • Conductive Additive : Carbon Black • Color : Black Working Temperature : Approx. 80-900C(Continuous), Approx. 100-1100C (Short Term) • Surface Resistance : <=105 Ohms cm Volume Resistance : <=105 Ohms cm • No Migration of corrosive substance Aging Behavior : No Derating of Conductivity Outstanding Ultraviolet Resistance

**Note :** We also manufacture antistatic products



## MAX CRATES :

Model	Available Versions	Outer Dimensions (L x B X H in mm)	Inner Dimensions (L x B X H in mm)
32100CON	CC	300 x 200 x 100	265 x 165 x 95
32150CON	CC	300 x 200 x 150	265 x 165 x 145
32200CON	CC	300 x 200 x 200	265 x 165 x 195
43090CON	CC	400 x 300 x 90	365 x 265 x 85
43120CON	CC	400 x 300 x 120	365 x 265 x 115
43175CON	CC	400 x 300 x 175	365 x 265 x 170
43220CON	CC	400 x 300 x 220	365 x 265 x 215
43320CON	CC	400 x 300 x 320	365 x 265 x 315
53100CON	CC / CCF	500 X 325 X 100	465 X 290 X 90
53200CON	CC	500 X 325 X 200	465 X 290 X 190
53250CON	CC	500 X 325 X 250	465 X 290 X 240
64120CON	CC	600 X 400 X 120	565 X 365 X 115
64175CON	CC	600 X 400 X 175	565 X 365 X 170
64220CON	CC / CH	600 X 400 X 220	565 X 365 X 215
64285CON	CC	600 X 400 X 285	565 X 365 X 280
64320CON	CC	600 X 400 X 320	565 X 365 X 315
64375CON	CC	600 X 400 X 375	565 X 365 X 370
LIDS FOR THE ABOVE SERIES CRATES (LID32000 + LID43000 + LID53000 + LID64000) ALSO AVAILABLE IN CONDUCTIVE SERIES			

## FRONT PARTLY OPEN CRATES :

Model	Available Versions	Outer Dimensions (L x B X H in mm)	Inner Dimensions (L x B X H in mm)
FPOCRATE1CON	FPO	95 x 102 x 52	61 x 100 x 50
FPOCRATE1PCON	FPO	95 x 102 x 52	61 x 100 x 50
FPOCRATE5CON	FPO	160 x 115 x 80	120 x 100 x 75
FPOCRATE15CON	FPO	200 x 125 x 100	160 x 105 x 190
FPOCRATE25CON	FPO	230 x 150 x 125	180 x 130 x 115
FPOCRATE35CON	FPO	300 x 210 x 160	275 x 204 x 149
FPOCRATE45CON	FPO	350 x 210 x 200	305 x 190 x 190
MAXCRATE20CON	MAX	230 x 130 x 125	-----
MAXCRATE30CON	MAX	300 x 180 x 145	-----
MAXCRATE40CON	MAX	450 x 180 x 145	-----
MAXCRATE47CON	MAX	295 x 365 x 145	-----
DWMAX20CON	MAX	110 (L) x 110 (H)	-----
DWMAX30/40CON	MAX	155 (L) x 125 (H)	-----
PCBPANELCON	PCB	-----	-----

# ACCESSORIES

NILKAMAL brings three decades of experience into designing plastic accessories which enhance the value of the crates in a speciality / dedicated application otherwise difficult to achieve. Standardising these accessories has helped in giving economic & quick solutions to the customer's Material Handling Problems. We are sure that these accessories will give you a perfect solution for your needs.

## LABLE HOLDERS :

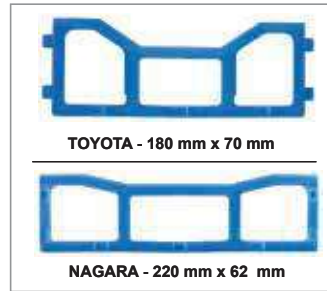
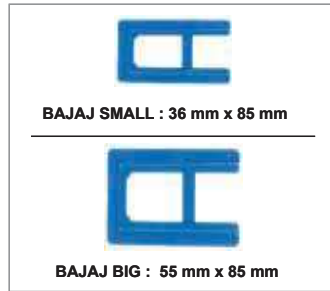
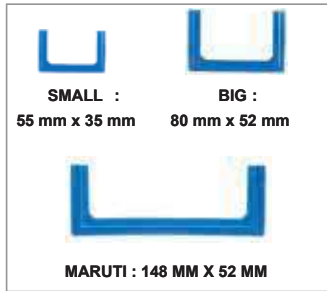

## 'L' TYPE SPACERS

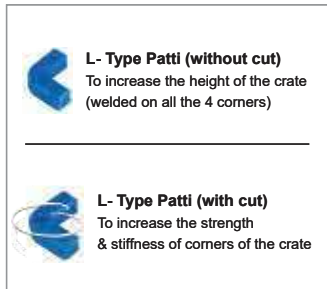

## ACRYLIC LABLE HOLDERS



## ACRYLIC FLAPS



## HANDLE ACCESSORIES

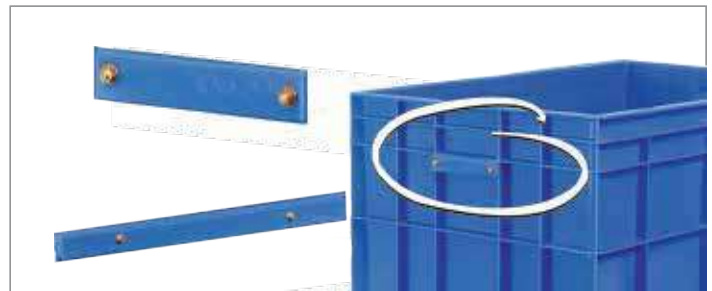

## CLOSING COVERS

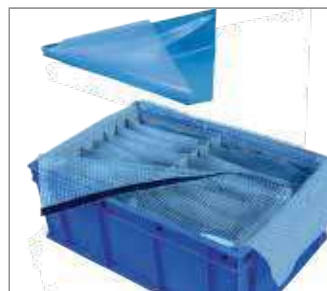

## SOFT / HARD FOAM



## LEGS

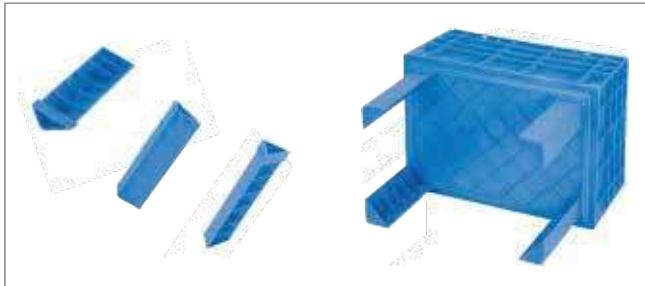

## 'U' TYPE CHANNEL

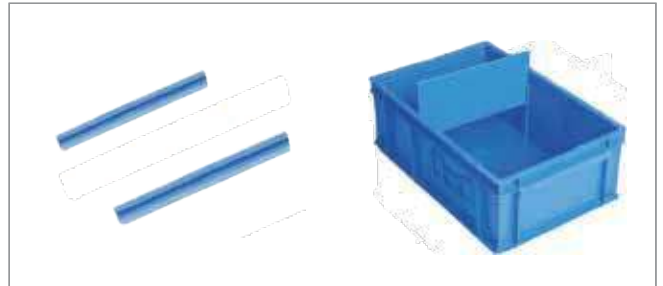

# ROTO MOLDED CRATES

Roto Moulded Crates are specially used for heavy components and tough applications. Nilkamal roto moulded crates are manufactured using advanced processes and with innovative designs to suit the needs of a demanding industry. Large sized crates are used in the textile industry for applications in spinning, fabric processing, weaving, dyeing and texturizing.



## MODELS AVAILABLE :

Model	Outer Dimensions (L x B X H in mm)	Capacity (approx.)
RMC342560	340 x 250 x 60	10 Kgs
RMC43150	400 X 300 X 150	14 Litres
RMC43175	400 X 300 X 175	16 Litres
RMC43220	400 X 300 X 220	20 Litres
RMC4828230	480 X 280 X 230	22 Litres
RMC493580	485 x 353 x 80	25 Kgs
RMCOR6125350	615 X 255 X 350	40 Litres
RMC6429340	645 X 295 X 340	40 Litres
RMC5236325	525 X 365 X 325	50 Litres
RMC7842215	775 X 420 X 215	51 Litres
RMC64285	600 X 400 X 285	60 Litres
RMC9855150	980 X 550 X 140	61 Litres
RMC7853230	780 X 530 X 230	65 Litres
RMC64320	600 X 400 X 320	70 Litres
RMC9055150	900 X 550 X 150	70 Litres
RMC5941380	595 X 410 X 380	75 Litres
RMC64375	600 X 400 X 375	80 Litres
RMC5941440	595 X 410 X 440	90 Litres
RMC6046500	600 X 460 X 500	90 Litres
RMC6047420	600 X 470 X 420	103 Litres
RMC86235	800 X 600 X 235	105 Litres
RMC9745315	975 X 450 X 315	115 Litres
RMC9746330	975 X 467 X 330	120 Litres
RMC6666312	665 X 665 X 312	125 Litres
RMC85330	810 X 568 X 330	127 Litres

Model	Outer Dimensions (L x B X H in mm)	Capacity (approx.)
RMC6041585	600 X 410 X 585	130 Litres
RMC6565370	650 X 650 X 370	135 Litres
RMC6666390	665 X 665 X 390	150 Litres
RMC6564430	650 X 645 X 430	150 Litres
RMC13045315	1300 X 450 X 315	155 Litres
RMC84640	815 X 410 X 640	190 Litres
RMC8242640	820 X 420 X 640	200 Litres
RMC86445	800 X 600 X 445	205 Litres
RMC8254540	820 X 545 X 540	220 Litres
RMC8256600	820 X 565 X 600	250 Litres
RMC8259660	820 X 590 X 660	265 Litres
RMC9462520	948 X 628 X 520	300 Litres
RMC1171675	1100 X 710 X 675	410 Litres
RMC9875710	980 X 750 X 710	450 Litres
RMC11476635	1140 X 760 X 635	550 Litres

## ROTO ELECTROPLATING PICKLING CRATES (REPC) :

Model	Outer Dimensions (L x B X H in mm)	Capacity (approx.)
REPC400	1025 X 660 X 645	400 Litres
REPC950	1220 X 1070 X 830	950 Litres
REPC1450	1830 X 1080 X 780	1450 Litres

Product list not exhaustive

# ROTO MOLDED CRATES

Nilkamal Roto Moulded Crates have a specially reinforced bottom to withstand rough handling on the shop floor. We have also successfully introduced roto moulded crates with palletized bottom for easy handling with MHE, as well as extra large sizes to handle large volumes. Our Doff Crates also find widespread acceptance in the textile industry throughout India.

## ROTO MOLDED CRATES WITH TROLLEY (RMCT) :

<b>RMCT400</b>	1025 X 660 X 645	400 Litres
<b>RMCT480</b>	900 X 750 X 750	480 Litres
<b>RMCT650</b>	1195 X 750 X 760	650 Litres
<b>RMCT950</b>	1220 X 1070 X 830	950 Litres
<b>RMCT1200</b>	1530 X 1070 X 770	1200 Litres
<b>RMCT1450</b>	1830 X 1080 X 780	1450 Litres
<b>RMCT1600</b>	1655 x 1220 x 1030	1600 Litres



## SPECIALIZED CRATES : CUSTOMIZED FABRICATED CRATES :

Symmetrical partition for instant visual inspection



Asymmetrical partition for engine / components assembly units



## AUTOMOBILE CRATES :



Model	Outer Dimensions (L x B X H in mm)	Inner Dimensions (L x B X H in mm)
86120	800 x 600 x 120	767 x 567 x 109
86230	800 x 600 x 230	767 x 567 x 219
86340	800 x 600 x 340	767 x 567 x 330
86450	800 x 600 x 450	767 x 567 x 440
124120	1200 x 400 x 120	1168 x 365 x 108
124230	1200 x 400 x 230	1167 x 365 x 218

CHC : Closed with Handle & Criss Cross Bottom

Nilkamal introduces a new Tablet Container for pharmaceutical industry. This container can be used to store tablet powder & capsules. It comes with 'No Ribs' on the body, hence cleaning becomes easy.



Model : **RCRDCON120L1**  
 Top Dia. : 510 mm.  
 Bottom Dia. : 495 mm.  
 Height : 640 mm.  
 Capacity : 120 ltrs.  
 Colors : White & Blue  
 Also available in :  
 50 litres (50L) & 100 litres (100L)



LID : **RCRDLID120L1**  
 Outside Dia. : 560 mm. ● Height : 45 mm.  
 Total Height : 650 mm.(Container + Lid)

# PLASTIC MILK CANS

## FEATURES

- Hygienic food grade industrial HDPE material.
- Light-weight easy-to-wash & clean, rust free & 100% maintenance free.
- Best for material handling in cold storage
- Ideal for storage & transportation of soft items like milk pouches
- Optimum utilisation of space during storage & transportation due to stackability

## ROTO MOULDED MILK CANS

Nilkamal's rotationally moulded hygienic milk cans have proven successful with dairy farmers for their superior design characteristics and handling ability.



**Model : RMILKCANDL20**

O.D. : 300 (Diameter) x 425 (H) MM.

Handles are solid and much stronger, round and smooth for easy gripping



**Model : RMILKCANDL40**

O.D. : 350 (Diameter) x 627 (H) MM.



**MODEL : RMILKCANDL50**

O.D. : 355 (Diameter) x 715 (H) MM



- Mouth Opening Diameter : 200 mm.
- Double layered with white inside
- Minimum bottom groove for easier & faster cleaning
- Smooth mouth for easy cleaning & hence does not allow dust to settle



**Model : RLIDMILKCAN40**

O.D. : 275 (Diameter) x 50 (H) MM.

- 1 Slots in lid facilitate sealing arrangement through a thread / rope woven through the slots and handles of the can. Lid can also be tied to the can handle in the same way to prevent its misplacement.
- 2 Extra Rib for stacking
- 3 Stackable due to matching ribs on lid and bottom
- 4 Stronger bottom due to special rib-on-rib design. It has a ridge for easy gripping while emptying the can.

## BLOW MOULDED MILK CANS

### FEATURES

- Mouth Opening Diameter : 200 mm.
- Double layered with white inside
- Minimum bottom groove for easier & faster cleaning
- Smooth mouth for easy cleaning & hence does not allow dust to settle



**Model : BMILKCAN5L**

Capacity : 5 Litres



**Model : BMILKCAN10L**

Capacity : 10 Litres



**Model : BMILKCAN15L**

Capacity : 15 Litres



**Model : BMILKCAN20L**

Capacity : 20 Litres



### LID FOR BLOW MOLDED MILK CAN

**Model : BMILKCANLIDWHT**

**Abbreviations : R : Roto Moulded • B : Blow Molded • O.D. : Outside Dimensions (All dimensions & capacities are approximate)**

# SHOPPING BASKET & TROLLEY

Nilkamal's Shopping Baskets used to pick up required products from the display racks & carry it to the cash counter.

## FEATURES

- Strong & sturdy expandable metal / plastic handle
- Smooth movement of wheel



### Model : SBTR50WH

Top Dimension OD : 557 (L)x 392 (W)  
 Bottom Dimension OD : 420 (L) x 270 (W)  
 Capacity : 52 Ltrs



### Model : SB25

O. D : 443 (L) x 335 (B) x 277 (H) mm.  
 I.D : 392 (L) x 282 (B) x 265 (H) mm.



### Model : SB26

O. D : 447 (L) x 344 (B) x 282 (H) mm.  
 I.D : 435 (L) x 322 (B) x 275 (H) mm.



# MAINTENANCE PRODUCTS :

Behind every efficient system, there is an efficient maintenance. Keeping the system running. Ensuring that the bits and bolts are always found when and where they are wanted. Tools and spare parts for repairs and replacement. All very organized and easy to access. Nilkamal's range of Tool Storage Cabinets. Organized spaces for tools, Nilkamal's FPO and Max crates. Easy to organize, easy to access, while Nilkamal's Caster wheels keep things moving. Nilkamal's Flexi Rack Universal Storage System. Organize your space, your way.



Tool Storage Cabinets - Shop Floor Application



Front Partly Open Crates



MAX Crates

# FRONT PARTLY OPEN (FPO) CRATES



FPO CRATE1



FPO CRATE1P



FPO CRATE5



FPO CRATE15



FPO CRATE25



FPO CRATE35



FPO CRATE45



FPO CRATE50



Model	Outer Dimensions (L x B X H in mm)	Inner Dimensions (L x B X H in mm)
FPO CRATE1	95 X 102 X 52	61 x 100 x 50
FPO CRATE1P	95 X 102 X 52	61 x 100 x 50
FPO CRATE5	160 x 115 x 80	120 x 100 x 75
FPO CRATE15	200 x 125 x 100	160 x 105 x 190
FPO CRATE25	230 x 150 x 125	180 x 130 x 115
FPO CRATE35	300 x 210 x 160	275 x 204 x 149
FPO CRATE45	350 x 210 x 200	305 x 190 x 190
FPO CRATE50	515 x 310 x 200	425 x 282 x 187

# FRONT PARTLY OPEN (FPO) CRATES



**FS-SS (Single Sided) & FS-DS (Double Sided) • Table Top Stands for FPO5 & FPO15 • FPO5 : 6 Channels - 5 Vertical x 6 Horizontal = 30 Nos. on FS-SS & 60 Nos. on FS-DS**  
**FPO15 : 5 Channels - 5 Vertical x 5 Horizontal = 25 Nos. on FS-SS & 50 Nos. on FS-DS • \* Also possible to accommodate 6 pcs. horizontally per channel per side**  
**Stand Dimensions : 725 mm. (Width) x 685 mm. (Height) x 450 mm. (Depth)**

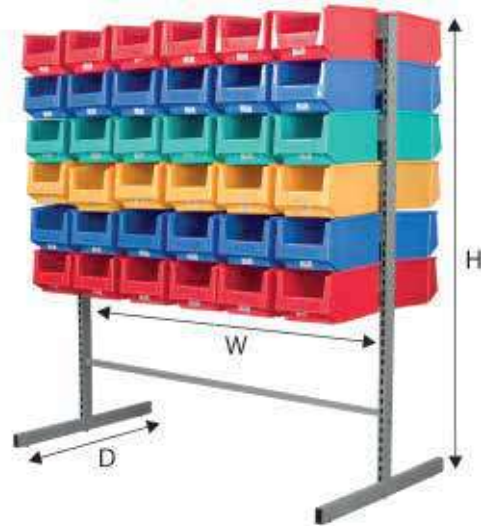

**FS-SS (Single Sided) & FS-DS (Double Sided) Stands for FPO CRATE25, 35 & 45 (Also available with Castors - Optional)**  
**FPO25 : 7 Channels - 7 Vertical x 9 Horizontal = 63 Nos. on FS-SS & 126 Nos. on FS-DS • FPO35 : 6 Channels - 6 Vertical x 6 Horizontal = 36 Nos. on FS-SS & 72 Nos. on FS-DS**  
**FPO45 : 5 Channels - 5 Vertical x 6 Horizontal = 30 Nos. on FS-SS & 60 Nos. on FS-DS • Stand Dimensions : 1410 mm. (Width) x 1550 mm. (Height) x 740 mm. (Depth)**



## MOUNTING OF FPO CRATES ON LOUVRE PANEL

Model No. : MLP4545 (457 X 457 MM)				
FPO5 3*X4 <sup>#</sup> =12	FPO15 3*X4 <sup>#</sup> =12	FPO25 3*X3 <sup>#</sup> =9	FPO35 2*X3 <sup>#</sup> =6	FPO45 2*X2 <sup>#</sup> =4
Model No. : MLP4561 (457 X 610 MM)				
FPO5 3*X5 <sup>#</sup> =15	FPO15 3*X5 <sup>#</sup> =15	FPO25 3*X4 <sup>#</sup> =12	FPO35 2*X4 <sup>#</sup> =8	FPO45 2*X3 <sup>#</sup> =6
Model No. : MLP4591 (457 X 915 MM)				
FPO5 3*X8 <sup>#</sup> =24	FPO15 3*X8 <sup>#</sup> =24	FPO25 3*X6 <sup>#</sup> =18	FPO35 2*X5 <sup>#</sup> =10	FPO45 2*X4 <sup>#</sup> =8
Model No. : MLP45183 (457 X 1830 MM)				
FPO5 3*X16 <sup>#</sup> =48	FPO15 3*X16 <sup>#</sup> =48	FPO25 3*X12 <sup>#</sup> =36	FPO35 2*X9 <sup>#</sup> =18	FPO45 2*X8 <sup>#</sup> =16

# MAX CRATES



**MAXCRATE10**  
O.D. : 173 (L) x 96 (B) x 86 (H) mm.



**MAXCRATE20**  
O.D. : 230 (L) x 130 (B) x 125 (H) mm.  
(Takes up to 3 dividers widthwise)



**MAXCRATE30**  
O.D. : 300 (L) x 180 (B) x 145 (H) mm.  
(Takes 1 divider lengthwise & up to 3 dividers widthwise)



**MAX CRATE40**  
O.D. : 450 (L) x 180 (B) x 145 (H) mm.  
(Takes 1 divider lengthwise & 7 dividers widthwise)



**MAX CRATE47**  
O.D. : 295 (L) x 365 (B) x 145 (H) mm.  
(Takes 3 dividers lengthwise)



**MAXCC65**  
O.D. : 377 (L) X 416 (B) X 180 (H) mm.  
(Takes up to 3 dividers lengthwise)

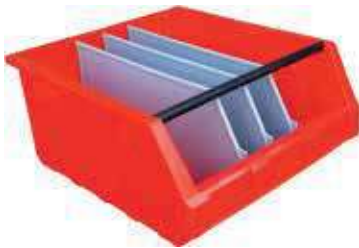

**MAXCRATE70**  
O.D. : 450 (L) x 410 (B) x 215 (H) mm.  
(Takes 3 dividers lengthwise)



**MAXCC75**  
O.D. : 470(L) x 420(B) x 293(H) MM  
I.D. : 436(L) x 375(B) X 282(H) MM Effective Height : 160 MM

Typical MAX Crate with  
Dust Cover and Flap



Close up of Dust  
Cover And Flap



**Model : DWMAX20**  
Width wise Dividers  
suitable for MAX Crates 20



**Model : DWFBMAX30/47**  
Divider Lengthwise  
For Max Crate 30 & 47



**Model : DWFBMAX40**  
Divider Lengthwise  
For Max Crate 40



**Model : DWFBMAX70**  
Divider Lengthwise  
For Max Crate 70



**Model : DWMAX30/40**  
Width wise Dividers  
for MAX Crates 30/40



**Model : DUSTCOVER30**  
Dust Cover For Max Crate 30



**Model : DUSTCOVER40**  
Dust Cover For Max Crate 40



**Model : FLAPMAX10**

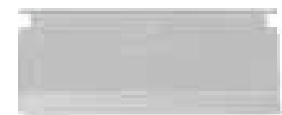

**Model : FLAPMAX10/30/40**

# LOUVRE PANELS



**MLP4545**

O.D. : 457 (W) x 457 (H) mm.

Table Top Unit with Rod Stand & Wall Mounted also available



**MLP4591L2DS2**

O.D. : 457 (W) X 910 (H) mm

(Double Sided with 2 legs)

(Also available with Table Top)



**MLP45183**

O.D. : 457 (W) X 1830 (H) mm

(Also available with legs on Single & Dual Sided Stand)



**MLP4561**

O.D. : 457 (W) x 610 (H) mm.

Wall Mounted & Table Top Unit also available

**MOUNTING OF MAX CRATES ON LOUVRE PANEL**

	MAX 10	MAX 20	MAX 20
<b>MLP4545 (457 x 457 MM)</b>	16 nos.	9 nos.	6 nos.
<b>MLP4561 (457 x 610 MM)</b>	20 nos.	12 nos.	8 nos.
<b>MLP4591 (457 x 915 MM)</b>	32 nos.	18 nos.	12 nos.
<b>MLP45183 (457 x 1830 MM)</b>	60 nos.	36 nos.	24 nos.

	MAX 40	MAX 47	MAX 70
<b>MLP4545 (457 x 457 MM)</b>	6 nos.	3 nos.	2 nos.
<b>MLP4561 (457 x 610 MM)</b>	8 nos.	4 nos.	3 nos.
<b>MLP4591 (457 x 915 MM)</b>	12 nos.	6 nos.	4 nos.
<b>MLP45183 (457 x 1830 MM)</b>	24 nos.	9 nos.	8 nos.

# TOOL STORAGE CABINETS

**Nilkamal Tool Storage Cabinets** are the ideal solutions for organized storage of your shop floor tools. You can store your tools without mix-ups, thus saving in shop floor usage. The systems are lockable, protecting your valuable tools against pilferage. **Nilkamal Tool Storage Cabinets** give you easy access to all tools stored; small items at the rear can also be easily accessed. The drawers are completely divisible to suit individual applications. Space saving, as you can store small components in high density. Movable models are also available.



Model : **NKTC333-X**  
 Overall Dimensions : 712 x 440 x 694 mm.  
 Dimensions With Castors : 712 x 440 x 814 mm.  
 Package : 746 x 462 x 348 mm.  
 2 drawers : 570 x 395 x 60 mm.



Model : **NKTBS-L4006-X**  
 Overall Dimensions : 426 x 458 x 844 mm.  
 Package : 495 x 525 x 910 mm.  
 5 drawers : 313 x 406 x 74.5 mm.  
 1 drawer : 313 x 406 x 311.5 mm.



Model : **NKTB8308D-X**  
 Overall Dimensions : 1412 x 745 x 662 mm.  
 Package : 1474 x 838 x 837 mm.  
 Top tray area : 1391 x 733 x 111.5 mm.  
 2 drawers : 371 x 675 x 79 mm.  
 2 drawers : 371 x 675 x 121 mm.  
 2 drawers : 777 x 675 x 79 mm.  
 2 drawers : 777 x 675 x 121 mm.



Model : **NKTB8312-DX**  
 Overall Dimensions : 1412 x 745 x 947 mm.  
 Package : 1474 x 838 x 1280 mm.  
 Dimensions With Castors : 1412 x 745 x 1176 mm.  
 1 drawer : 1229.5 x 675 x 123 mm.  
 3 drawers : 371 x 675 x 79 mm.  
 1 drawer : 371 x 675 x 107 mm.  
 1 drawer : 371 x 675 x 275 mm.  
 3 drawers : 777 x 675 x 79 mm.  
 2 drawers : 777 x 675 x 107 mm.  
 1 drawer : 777 x 675 x 163 mm.



Model : **NKTBR5008-X**  
 Overall Dimensions : 910 x 550 x 947 mm.  
 Dimensions With Castors : 910 x 550 x 1095 mm.  
 Package : 990 x 640 x 1115 mm.  
 4 drawers : 790 x 479 x 53 mm.  
 3 drawers : 790 x 479 x 109 mm.  
 1 drawer : 790 x 479 x 221 mm.



Model : **NKTBR-L4007**  
 Overall Dimensions : 680 x 458 x 856 mm.  
 Dimensions With Castors : 680 x 458 x 995 mm.  
 Package : 749 x 520 x 935 mm.  
 5 drawers : 570 x 406 x 74.5 mm.  
 2 drawers : 570 x 406 x 153.5 mm.



Model : **NKTBS-L4007-X**  
 Overall Dimensions : 426 x 458 x 844 mm.  
 Package : 495 x 525 x 910 mm.  
 5 drawers : 313 x 406 x 74.5 mm.  
 2 drawers : 313 x 406 x 153.5 mm.

TBR : Roller Cabinet with Castors ●TBS: Tool Cabinet with Slide ●TBT : Tool Cabinet Top Chest ●TC : Tool Cart ●L : New Drawer Structure ●X : With Ball Bearing Slide (All Dimensions are approximate)

# MODULAR CRATES & RACKS :

Modular storage crates and Electro Conveyance Crates are widely used in Electronics and Electrical industry for storage and movement .



**Model : HMTR**  
 (Horizontal format with modular storage crate 275 / 300) (24 nos. each)  
 O.D. 910 (L) X 320 (B) X 615 (H) MM.  
**(Also available without castors)**



**Model : VMTR**  
 (Vertical format with modular storage crate 275 / 300) (24 nos. each)  
 O.D 500 (L) X 320 (B) X 1110 (H) MM.  
**(Also available without castors)**



## Modular Storage Crates



**MODEL : 300 With Removable Partition**  
 With 3 Partitions & 4 Pockets (Also available Model : 275 with 1 partition & 2 pockets)

## Electro Conveyance Crates



**MODEL : ECC12**  
 Box Size : 230 (L) X 164 (B) X 154 (H) mm. • Drawer Size : 149 (L) X 72 (B) X 31(H) mm.

## Modular Storage Crates & Modular Storage Racks



**MODEL : CC8080**  
 O.D : 80 (L) X 80 (B) X 31(H) mm.



**MODEL : CC16080**  
 O.D : 160 (L) X 80 (B) X 31 (H) mm.

(Each rack can accommodate 24 trays respectively)

# RETURNABLES FOR REVERSE LOGISTICS

The 'win-win investment' that saves on packaging costs for automotives and ancillary OEMs. A lot of money can be saved if the packaging in which the goods are packed can be re-used. Nilkamal's returnable packing products are ideal money savers for goods that need to be transported over short distances. Nilkamal Vacuum Formed Crates and trays provide snug and rattle free protection during transport. PP Corrugated Boxes are foldable (rigid form optional) and can be re-used many times. Textile Packaging is ideal for scratch sensitive shiny components. Pallet Sleeve Boxes offer protection and an excellent dispatch to return ratio, paying for their cost many times over.



Vacuum formed crates for gears



PP corrugated boxes



Pallet sleeve systems - also available on rent

# SPACE SAVING CRATES

## STACKABLE & NESTABLE (SN) CRATES



**Model : CH8045270SNBLU**  
 O.D. : 800 (L) x 450 (W) x 267 (H) in mm  
 I.D. : 753.5 (L) x 403 (W) x 260 (H) in mm  
 (CH : Closed with Handle)



**Model : CH8855230SNBLU**  
 O.D. : 887 (L) x 558 (W) x 234 (H) in mm  
 I.D. : 825 (L) x 501 (W) x 228 (H) in mm  
 (CH : Closed with Handle)



**Model : CH5838210**  
**OUTSIDE DIMENSIONS** (LXBXH) 580 X 380 X 210 MM.  
**INSIDE DIMENSIONS** (LXBXH) 553 X 353 X 205 MM.  
 (CH : Closed With Handle)



**Model : JR5838210**  
**OUTSIDE DIMENSIONS** (LXBXH) 580 X 380 X 210 MM.  
**INSIDE DIMENSIONS** (LXBXH) 553 X 353 X 205 MM.  
 (JR : Perforated From Bottom & All Sides)  
 Also Available In JBC



**Model : JR4645178**  
**OUTSIDE DIMENSIONS** (LXBXH) 460 X 450 X 178 MM.  
**INSIDE DIMENSIONS** (LXBXH) 410 X 407 X 168 MM.  
 (JR : Perforated From Bottom & All Sides)



**Model : JR6238300**  
**OUTSIDE DIMENSIONS** (LXBXH) 626 X 361 X 300 MM.  
**INSIDE DIMENSIONS** (LXBXH) 590 X 345 X 293 MM.  
 (JBC : Perforated From All Sides & Bottom Closed)  
 Also Available In CH / JR



**Model : CC3727130**  
**OUTSIDE DIMENSIONS** (LXBXH) 370 X 270 X 130 MM.  
**INSIDE DIMENSIONS** (LXBXH) 320 X 236 X 130 MM.  
 Available only in CC  
 (CC : Complete Closed)



**Model : CC 4030150**  
**OUTSIDE DIMENSIONS** (LXBXH) 400 X 300 X 150 MM.  
**INSIDE DIMENSIONS** (LXBXH) 350 X 266 X 149 MM.  
 Available only in CC  
 (CC : Complete Closed)



**Model : CH 63325**  
**OUTSIDE DIMENSIONS** (LXBXH) 650 X 370 X 325 MM.  
**INSIDE DIMENSIONS** (LXBXH) 485 X 300 X 295 MM.  
 Available only in CH version  
 (CH : Complete Closed with Handle)

# SPACE SAVING CRATES

## FOLDABLE CRATES

These crates are specially designed for SPACE SAVING during reverse logistics. With the Nilkamal range of Foldable Crates, you are assured of highly durable and re-usable walls that ensure low replacement cost. Explore our different variants specially designed for various applications.

350 Series



Any other colour subject to bulk quantity

OUTSIDE DIMENSIONS 594 x 396 x 353 MM  
INSIDE DIMENSIONS (L X B X H) 564 x 370 x 346 MM

Also available in  
CC/CCC/CCT/JBC/JBCC/JBT

350 Series



Any other colour subject to bulk quantity

OUTSIDE DIMENSIONS 594 x 396 x 353 MM  
INSIDE DIMENSIONS (L X B X H) 564 x 370 x 346 MM

Also available in  
CC/CCC/CCT/JBC/JBCC/JBT

In Folding Position



Folded + Stacked Height : 324.0 MM  
(\*4 crate in folding position)

UP TO  
70%  
SPACE SAVING

Stacking



Open + Stacked Height : 1412 MM  
(\*4 crate in Stacking position)

MODEL	Folding Height	Available Version	Outer Dimensions	Inner Dimensions
64120FC	47mm	CC/CCC/CCT	594 (L) x 396 (B) x 118 (H)	564 (L) x 370 (B) x 111 (H)
64175FC	47mm	CC/CCC/CCT/JBC/JBCC/JBT	594 (L) x 396 (B) x 178 (H)	564 (L) x 370 (B) x 171 (H)
64190FC	47mm	CC/CCC/CCT/JBC/JBCC/JBT	600 (L) x 400 (B) x 190 (H)	568 (L) x 365 (B) x 181 (H)
64200FC	47mm	CC/CH/CCT/CHT	600 (L) x 400 (B) x 197 (H)	568 (L) x 365 (B) x 190 (H)
64230FC	54 mm	CC/CCC/CCT/JBC/JBCC/JBT	594 (L) x 396 (B) x 233 (H)	564 (L) x 370 (B) x 225 (H)
64350FC	81 mm	CC/CCC/CCT/JBC/JBCC/JBT	594 (L) x 396 (B) x 353 (H)	564 (L) x 370 (B) x 346 (H)
43120FC	47 mm	CC/CCC/CCT	394 (L) x 296 (B) x 118 (H)	368 (L) x 266 (B) x 111 (H)
43230FC	81 mm	CC/CCC/CCT/JBC/JBCC/JBT	394 (L) x 296 (B) x 233 (H)	368 (L) x 266 (B) x 226 (H)

\* All Designs applied for Registration

Available in Various Bottom



Ribbed Bottom



Cris Cross Bottom



Textured Bottom

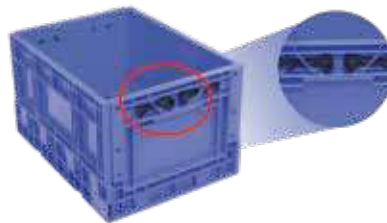

Quick Dismantling System

Crate Folding Height : 81.0 MM



Folded

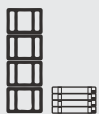

Space Saving  
Stacking and nesting



Replaceable Wall



Available in  
Various Sizes



Lid  
Available



Quick  
Dismantling System

Abbreviations used : CC : Complete Closed • CH : Closed with Handle • CCC: Complete Closed with Cris Cross • CCT: Complete Closed with Textured  
• CHT : Closed with Handle and Texture • FC: Foldable Crate

# SPACE SAVING CRATES

## ATTACHED LID CRATES

Nilkamal introduces the Attached LID Crates (ALC), an ideal storage solution for closed-loop distribution or reverses logistics. ALC is nestable and stackable crates with two parts interlocking hinged lid, this protect your goods from dust and damage. Nilkamal ALC are designed to stack with the lid closed and nest when empty, thus saving precious space for you. Strong built-in and economically designed for easy handling. The locking eyelet provides a security option. Perfect for internal storage or Warehousing for Auto parts distribution centres, Supermarkets, Retails chain DCs, Logistics, Service Vehicles, File Storage and many more.

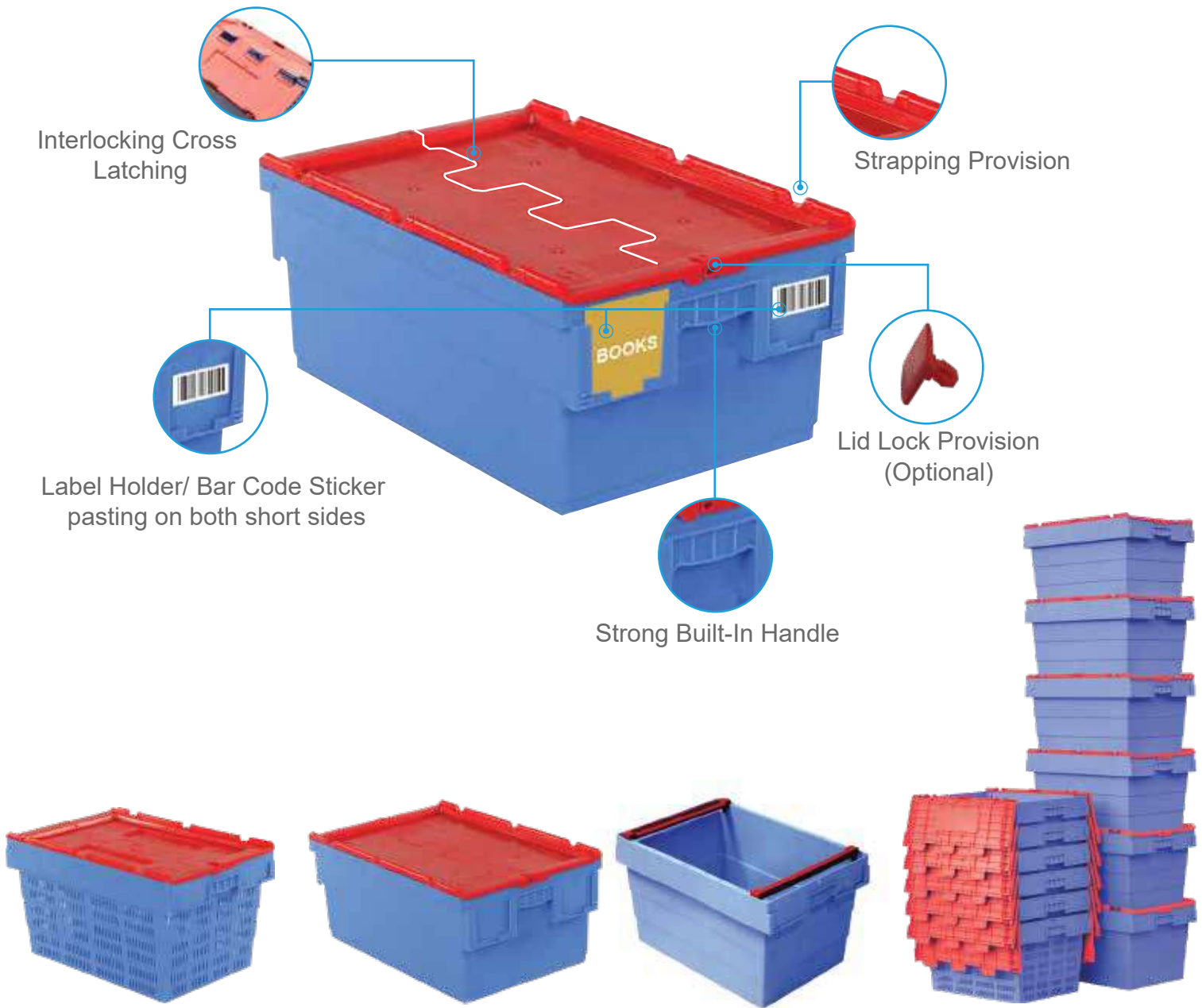

MODEL	Height	Available Version	Outer Dimensions	Inner Dimensions
400 X 300	210 MM	CC / CCT	400 (L) x 300 (B) x 210 (H) MM	365 (L) x 270 (B) x 198 (H) MM
400 X 300	270 MM	CC / CCT	400 (L) x 300 (B) x 270 (H) MM	365 (L) x 270 (B) x 259 (H) MM
400 X 300	295 MM	CC / CCT	400 (L) x 300 (B) x 295 (H) MM	365 (L) x 270 (B) x 284 (H) MM
600 X 400	250 MM	CC / CCT	600 (L) x 400 (B) x 250 (H) MM	550 (L) x 365 (B) x 245 (H) MM
600 X 400	300 MM	CC / CCT	600 (L) x 400 (B) x 300 (H) MM	550 (L) x 365 (B) x 295 (H) MM
600 X 400	320 MM	CC / CCF / JR /JBC / JBF	600 (L) x 400 (B) x 320 (H) MM	540 (L) x 370 (B) x 317 (H) MM
600 X 400	350 MM	CC / CCT	600 (L) x 400 (B) x 350 (H) MM	550 (L) x 366 (B) x 347 (H) MM
6238300	300 MM	CHF / CH / JR / JBC	628 (L) x 383 (B) x 300 (H) MM	595 (L) x 347 (B) x 294 (H) MM
43240DW	240 MM	CCT	400 (L) x 300 (B) x 240 (H) MM	365 (L) x 265 (B) x 235 (H) MM
64320BA	320 MM	CC / JBC / JR	600 (L) x 400 (B) x 320 (H) MM	538 (L) x 370 (B) x 317 (H) MM

\* All Designs applied for Registration

Abbreviations used : • ALC : Attached Lid Crate • CC : Complete Closed with Ribbed Bottom • CCT: Complete Closed with Textured Bottom • CCF : Complete Closed with Flat Bottom • CHF : Closed with Handle & Flat Bottom • JBC : Jali with Closed Bottom • JBF : Jali with Flat Bottom • JR : Jali Regular

# PP CORRUGATED FOLDABLE BOXES / CRATES

Flexible, lightweight and safe to handle. Can be folded multiple times, reusable. For movement of light weight but voluminous products.



Stackable Crate (with PVC profile)



Universal Foldable Box (201 Type)



Universal Foldable Box (with Full Flap , 203 Type)



## TEXTILE PACKAGING SOLUTIONS :

Scratch sensitive parts and components such as glass, lights, mirrors and chrome plated components need special care in transport. Switch to Nilkamal's Textile Partition Systems to safely protect your most sensitive parts from damage. Our engineered designs offer maximum density through textile flexibility, allowing the most effective nesting of components and multiple part use. Following are the unique features :

- Little weight hence lifting with more products is possible within ergonomic restrictions reducing handling & transportation cost
- Thin (<1.0 mm.) hence lifting High density pack designs are possible.
- Maintains ideal balance between cost savings & durability
- Easy to keep odd-size products inside the textile partitions



Crate With Textile Partition with Double Layer



PP Crate (with Textile Partition)



PP Crate Fit Box (with Dust Cover)



Textile Fitment (with Close Pocket & Dust Cover)



Trolley With Textile Partition (Empty & Loaded)

# PALLET SLEEVE SYSTEMS - (Also Available On Rent)

Ideal system for maximizing space in return cycles. 100% recyclable. Saves space for return transportation.



Available sizes : 1200 x 800 mm. / 1200 x 1000 mm.

## QUICK ASSEMBLING :

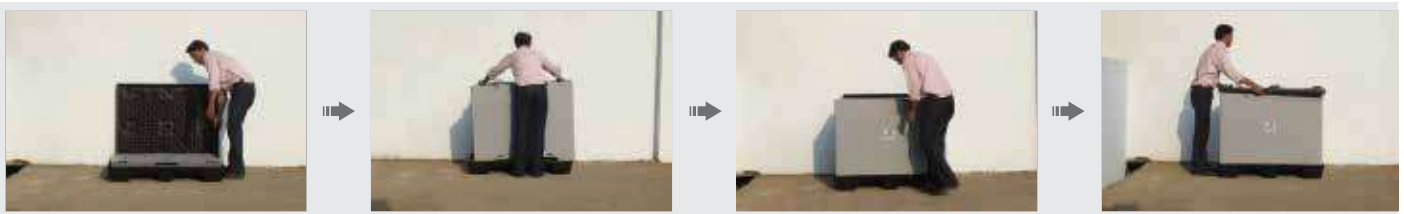

## EASY DISMANTLING :

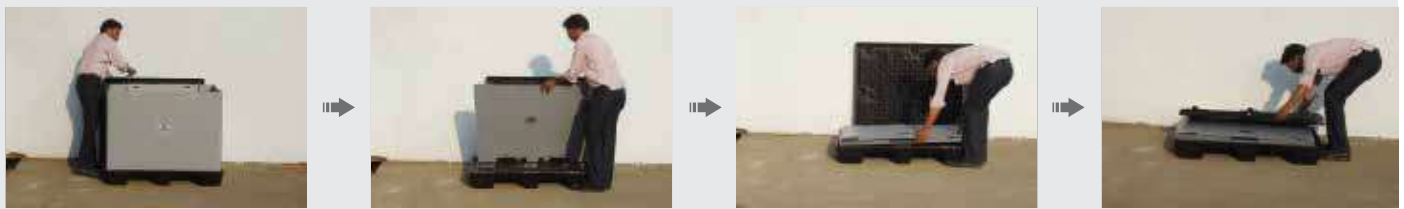

# VACUUM FORMED CRATES

Custom shaped crates and trays for products that need protective packaging for transportation of valuable and innovative components for automotive industry across India.



Available in Pallet size moulds :



Available in Standard series crate fitments :



# ROTO MOLDED PALLETISED CRATE

Storing huge quantities and suitable to handle with all kinds of manual pallet truck. Roto Moulded Crates have a specially reinforced bottom and long life



**Model : RMPC320**  
Capacity: 320 Ltr  
O.D. : 750 (L) X 805 (W) X 653 (H) MM  
I.D. : 750 (L) X 805 (W) X 653 (H) MM



**Model : RMPC500**  
Capacity: 500 Ltr  
O.D. : 1300(L) x 1300(B) x 590(H) MM  
I.D. : 1220(L) x 1220(B) x 380(H) MM



**Model : RMPC1000**  
Capacity: 950 Ltr  
Static Load: 500 KG  
Dynamic Load: 500 KG  
O.D. : 1220(L) x 1220(W) x 935(H) MM

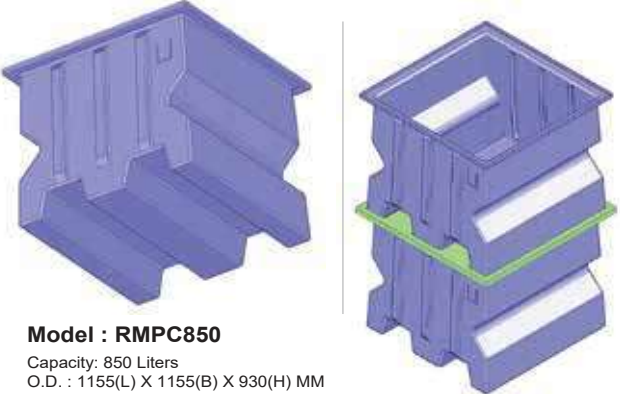

**Model : RMPC850**  
Capacity: 850 Liters  
O.D. : 1155(L) X 1155(B) X 930(H) MM  
I. D. : 1020(L) X 1020(B) X 923(H) MM



**Model : RMPC415**  
Capacity: 415 Liters  
O.D. : 840(L) X 840(B) X 730(H) MM  
I. D. : 795(L) X 795(B) X 600(H) MM



**Model : RMPCLID**  
Capacity: 415 Liters  
O.D. : 840(L) X 840(B) X 730(H) MM  
I. D. : 795(L) X 795(B) X 600(H) MM

# Vaccine

## Cold boxes and carriers



**We Protect your product**  
Increase your storage  
Improve your Labor Productivity  
**While enhancing Safety, Hygiene, & Ergonomics**

# ICE PACKS

Ice Packs are crucial to the maintenance of temperature over the prescribed distance and are tested rigorously conforming to W.H.O norms.



**BIP-3**



**BIP-4**



**BIP-6**

	BIP-3	BIP-4	BIP-6
Material	HDPE	HDPE	HDPE
Volume of Ice Packs	0.30 Litres	0.40 Litres	0.60 Litres
External Dimensions	163 x 90.5 x 33 mm	165 x 95 x 33 mm	190 x 121 x 35 mm
Weight Empty	75 gms	76 gms	114 gms
Weight Filled	370 gms	431 gms	650 gms
Performance : Conforming to WHO PQS Performance Specifications	WHO/PQS/E005/IP01.2	WHO/PQS/E005/IP01.2	WHO/PQS/E005/IP01.2



# COLD VACCINE CARRIERS

An ISO 9001:2008 Company with a proven product range of insulated Products, Nilkamal has the expertise in manufacturing and supplying a wide range of vaccine carriers conforming to W.H.O norms. Our products are widely acclaimed for their sturdiness and durability.



Reinforced bottom



Conforming to W.H.O specifications complied



Easy to carry



ISO 9001, ISO 14001, ISO 45001, ISO 13485:2016 and CE certified



	BBVC-23	BCVC-43	BCVC-43A	BCVC-44B
Vaccine Storage Capacity	0.91 Ltrs.	1.534 Ltrs.	1.44 Ltrs.	1.48 Ltrs.
Weight Fully Loaded	2.4 Kgs.	4.9 kgs.	3.8 kgs.	3.32 Kgs.
Weight Empty (Without Icepacks)	1.3 kgs.	2.6 kgs.	1.62 kgs.	1.64 kgs.
External Surface Material	HDPE	HDPE	HDPE	HDPE
Internal Lining Material	HIPS	HIPS	HIPS	HIPS
Insulation Material	CFC-free Polyurethane	CFC-free Polyurethane	CFC-free Polyurethane	CFC-free Polyurethane
Insulation Thickness	35 - 45 mm	45 - 105 mm	40 - 100 mm	40 - 100 mm
External Dimensions (Approx)	24.6 (L) x 18 (W) x 21.5 (H) cm	28 (L) x 28 (W) x 31.5 (H) cm	25.2 (L) x 25.2 (W) x 30.5 (H) cm	25.3 (L) x 25.3 (W) x 30.5 (H) cm
Internal Dimensions (Approx)	17.4 (L) x 10.5 (W) x 12 (H) cm	16.5(L) x 16.5 (W) x 20 (H) cm	16.5 (L) x 16.5 (W) x 16.5 (H) cm	16.3 (L) x 16.3 (W) x 16.4 (H) cm
Vaccine Storage Dimensions	17.4 (L) x 10.5 (W) x 5 (H) cm	9.5 (L) x 9.5 (W) x 17 (H) cm	9.5 (L) x 9.5 (W) x 16 (H) cm	9.5 (L) x 9.5 (W) x 16.4 (H) cm
Lid Type & Fixing	Removable	Removable	Removable	Removable
No. of Ice packs required	2	4	4	4
No. of Ice packs supplied	2	4	4	4
Ice Pack type	WHO/PQS/E005/IP01.2	WHO/PQS/E005/IP01.2	WHO/PQS/E005/IP01.2	WHO/PQS/E005/IP01.2
Volume of Ice Packs	0.30 Ltrs.	0.30 Ltrs.	0.30 Ltrs.	0.40 Ltrs.
Size of Ice Packs	163 (L) x 90.5 (W) x 33 (H) cm	163 (L) x 90.5 (W) x 33 (H) mm	163 (L) x 90.5 (W) x 33 (H) mm	165 (L) x 95 (W) x 33 (H) cm
PERFORMANCE	Confirming to WHO specifications Cold Life Requirement as per WHO at 43° C without opening :	E004/VC01-VP.2	E004/VC01-VP.2	E004/VC01-VP.2
	Actual Cold life without opening at 43° C as tested	17 hrs. 50 min	41 hrs. 2 min	40 hrs. 30 min







# COLD VACCINE CARRIERS



	BDVC-44	BCVC-46	BDVC-46
Vaccine Storage Capacity	1.7 Ltrs	2.736 Ltrs.	3.36 Ltrs.
Weight Fully Loaded	3.34 kgs.	6.4 kgs.	5.17 kgs.
Weight Empty (Without Icepacks)	1.65 kgs.	2.32 kgs.	2.51 kgs.
External Surface Material	HDPE	HDPE	HDPE
Internal Lining Material	HIPS	HIPS	HIPS
Insulation Material	CFC-free Polyurethane	CFC-free Polyurethane	CFC-free Polyurethane
Insulation Thickness	40 - 45 mm	28 - 58 mm	40 mm
External Dimensions (Approx)	25.2 (L) x 26.0 (W) x 30.5 (H) cm	27 (W) x 27 (D) x 32 (H) cm	29.5 (L) x 29.5 (W) x 33.5 (H) cm
Internal Dimensions (Approx)	17.0 (L) x 17.0 (W) x 16.4 (H) cm	19 (L) x 19 (W) x 19 (H) cm	20.2 (L) x 20.2 (W) x 19.4 (H) cm
Vaccine Storage Dimensions	10.2 (L) x 10.2 (W) x 16.4 (H) cm	12 (L) x 12 (W) x 19 (H) cm	13.3 (L) x 13.3 (W) x 19.0 (H) cm
Lid Type & Fixing	Removable	Removable	Removable
No. of Ice packs required	4	4	4
No. of Ice packs supplied	4	4	4
Ice Pack type	WHO/PQS/E005/IP01.3	WHO/PQS/E005/IP01.3	WHO/PQS/E005/IP01.3
Volume of Ice Packs	0.40 Ltrs.	0.60 Ltrs.	0.60 Ltrs.
Size of Ice Packs	165 (L) x 95 (W) x 33 (H) mm	190(L) x 121 (W) x 35 (H) mm	190 (L) x 121 (W) x 35 (H) mm
<b>PERFORMANCE</b>	Confirming to WHO specifications Cold Life Requirement as per WHO at 43° C without opening :	E004/VC01-VP.2	E004/VC01-VP.2
	Actual Cold life without opening at 43° C as tested	38 hrs. 37 min	46 hrs. 23 min

# VACCINE COLD BOXES - SHORT RANGE

Vaccine Cold Boxes are stackable with re-inforced wall are tested rigorously conforming to W.H.O norms

-  Stackable
-  In-built handle for lifting
-  Integral, hinged lid with stopper
-  Rib-on-rib bottom
-  ISO 9001, ISO 14001, ISO 45001, ISO 13485:2016 and CE certified
-  W.H.O specifications complied



	RCB 244 SS	RCB 324 SS	RCB 246 LS
Vaccine Storage Capacity	10.7 Ltrs.	15 Ltrs.	16 Ltrs.
Weight Fully Loaded	18.14 kgs.	33.85 kgs.	34.8 kgs.
Weight Empty (Without Icepacks)	8.18 kgs.	12.2 kgs.	12.1 kgs.
External Surface Material	LLDPE	LLDPE	LLDPE
Internal Lining Material	LLDPE	LLDPE	LLDPE
Insulation Material	CFC-free Polyurethane	CFC-free Polyurethane	CFC-free Polyurethane
Insulation Thickness	46 - 61 mm	65 - 115 mm	65 - 115 mm
External Dimensions (Approx)	49.3 (L) x 45.5 (W) x 39.7 (H) cm	65 (L) x 65 (W) x 37 (H) cm	65 (L) x 65 (W) x 37 (H) cm
Internal Dimensions (Approx)	36.2 (L) x 29.4 (W) x 25.4 (H) cm	48 (L) x 48 (W) x 20 (H) cm	48 (L) x 48 (W) x 21 (H) cm
Vaccine Storage Dimensions	22.3 (L) x 29.3 (W) x 16.4 (H) cm	41 (L) x 41 (W) x 9 (H) cm	40 (L) x 40 (W) x 11.00 (H) cm
Lid Type & Fixing	Integrated Hinged	Integrated Hinged	Integrated Hinged
No. of Ice packs required	24	32	24
No. of Ice packs supplied	24	32	24
Ice Pack type	WHO/PQS/E005/IP01.3	WHO/PQS/E005/IP01.3	WHO/PQS/E005/IP01.3
Volume of Ice Packs	0.40 Ltrs.	0.40 Ltrs.	0.60 Ltrs.
Size of Ice Packs	165 (L) x 95 (W) x 33 (H) mm	165 (L) x 95 (W) x 33 (H) mm	190 (L) x 121 (W) x 35 (H) mm
PERFORMANCE	Confirming to WHO specifications Cold Life Requirement as per WHO at 43° C without opening :	E004/CB01-VP.3	E004/CB01-VP.3
	Actual Cold life without opening at 43° C as tested	73 hrs. 8 min	53hrs. 36 min

# VACCINE COLD BOXES - LONG RANGE



	RCB 264 SL	RCB 424L	RCB 444L-A
Vaccine Storage Capacity	6 Ltrs.	12 Ltrs.	20.25 Ltrs.
Weight Fully Loaded	27.54 kgs.	41 kgs.	49.7 kgs.
Weight Empty (Without Icepacks)	13.25 kgs.	18.78 kgs.	20.52 kgs.
External Surface Material	LLDPE	LLDPE	LLDPE
Internal Lining Material	LLDPE	LLDPE	LLDPE
Insulation Material	CFC-free Polyurethane	CFC-free Polyurethane	CFC-free Polyurethane
Insulation Thickness	100 mm	100 mm	111 mm
External Dimensions (Approx)	65 (L) x 53 (W) x 46 (H) cm	60 (L) x 60.5 (W) x 56.2 (H)cm	77 (L) x 62 (W) x 53.5 (H) cm
Internal Dimensions (Approx)	40 (L) x 27.8 (W) x 20 (H) cm	34.4 (L) x 33.3 (W) x 34.5 (H)cm	51 (L) x 36 (W) x 27.5 (H) cm
Vaccine Storage Dimensions	32 (L) x 21 (W) x 10 (H) cm	27 (L) x 19.5 (W) x 23 (H)cm	45 (L) x 30 (W) x 15 (H) cm
Lid Type & Fixing	Integrated Hinged	Integrated Hinged	Integrated Hinged
No. of Ice packs required	26	42	44
No. of Ice packs supplied	26	42	44
Ice Pack type	WHO/PQS/E005/IP01.3	WHO/PQS/ E005/IP01.3	WHO/PQS/E005/IP01.3
Volume of Ice Packs	0.40 Ltrs.	0.40 Ltrs.	0.40 Ltrs.
Size of Ice Packs	165 (L) x 95 (W) x 33 (H) mm	165 (W) x 95 (D) x 33 (H) mm	165 (L) x 95 (W) x 33 (H) mm
Confirming to WHO specifications Cold Life Requirement as per WHO at 43° C without opening :	E004/CB01-VP.3	WHO/PQS/E004/CB01-VP.3	E004/CB01-VP.3
Actual Cold life without opening at 43° C as tested	106 hrs.	170 hrs. 29 min	152 hrs. 28 min

PERFORMANCE

# VACCINE COLD BOXES - LONG RANGE

	RCB 316L	RCB 444L	RCB 503L
Vaccine Storage Capacity	21.92 Ltrs.	23 Ltrs.	23.7 Ltrs.
Weight Fully Loaded	49.91 kgs.	38 kgs.	49.32 kgs.
Weight Empty (Without Icepacks)	19.15 kgs.	17 kgs.	19.15 kgs.
External Surface Material	LLDPE	LLDPE	LLDPE
Internal Lining Material	LLDPE	LLDPE	LLDPE
Insulation Material	CFC-free Polyurethane	CFC-free Polyurethane	CFC-free Polyurethane
Insulation Thickness	111 mm	111 mm	111 mm
External Dimensions (Approx)	78.5 (L) x 63.2 (W) x 53.3 (H) cm	77.4 (L) x 61.6 (W) x 53 (H) cm	78.5 (L) x 63.2 (W) x 53.3 (H) cm
Internal Dimensions (Approx)	54.2 (L) x 38.6 (W) x 28.5 (H) cm	52.8 (L) x 38.2 (W) x 28.2 (H) cm	53.5 (L) x 39.2 (W) x 28.6 (H) cm
Vaccine Storage Dimensions	45.5 (L) x 31.7 (W) x 15.2 (H) cm	45 (L) x 30 (W) x 17 (H) cm	46.8 (L) x 31.3 (W) x 16.2 (H) cm
Lid Type & Fixing	Integrated Hinged	Integrated Hinged	Integrated Hinged
No. of Ice packs required	31	44	50
No. of Ice packs supplied	31	44	50
Ice Pack type	WHO/PQS/E005/IP01.3	WHO/PQS/E005/IP01.3	WHO/PQS/E005/IP01.3
Volume of Ice Packs	0.60 Ltrs.	0.40 Ltrs.	0.30 Ltrs.
Size of Ice Packs	190 (L) x 121 (W) x 35 (H) mm	165 (L) x 95 (W) x 33 (H) mm	163 (L) x 90.5 (W) x 33 (H) mm
Confirming to WHO specifications Cold Life Requirement as per WHO at 43° C without opening :	E004/CB01-VP.3	E004/CB01-VP.3	E004/CB01-VP.3
Actual Cold life without opening at 43° C as tested	145 hrs. 15 min	130 hrs.	131 hrs.

PERFORMANCE



**Disclaimer:** Image and accessories shown may differ from the actual equipment. technical specifications are subject to change without any prior notice

# FREEZE FREE VACCINE CARRIERS

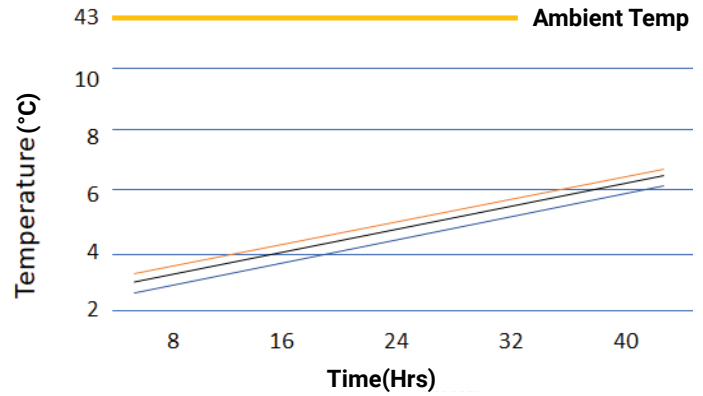

WHO PQS E004/058 Vaccine carrier of capacity 1.5 L



No longer at a risk of freezing.



Protect the vaccine's potency.



Built-in barrier shields the vaccines from reaching negative temperatures and excessive heat.

	BCVC46LFF	BCVC44LFF	BCVC46L1FF
Vaccine Storage Capacity	1.51 Ltrs.	1.53 Ltrs.	2.1 Ltrs.
Weight Fully Loaded	7.6 kgs.	5.20 kgs.	6.66 kgs
Weight Empty (Without Packs)	3.76 kgs.	2.75 kgs.	3.00 kgs
External Surface Material	HDPE	HDPE	HDPE
Internal Lining Material	HIPS	HIPS	HIPS
Insulation Material	Polyurethane	Polyurethane	Polyurethane
Insulation Thickness	34 mm	34 mm	44 mm
External Dimensions (Approx)	31.8 (L) x 31.8 (W) x 29.5 (H) cm	31.8 (L) x 31.8 (W) x 29.5(H) cm	31.02 (L) x 30.97 (W) x 30.13 (H) cm
Internal Dimensions (Approx)	9.50 (L) x 9.50 (W) x 16.80 (H) cm	9.50 (L) x 9.50 (W) x 16.80 (H) cm	10.98 (L) x 10.97 (W) x 18.60 (H) cm
Vaccine Storage Dimensions	9.50 (L) x 9.50 (W) x 16.80 (H) cm	9.50 (L) x 9.50 (W) x 16.80 (H) cm	10.98 (L) x 10.97 (W) x 18.60 (H) cm
Lid Type & Fixing	Removable	Removable	Removable
No. of Ice packs required	4	4	4
No. of Ice packs supplied	4	4	4
Ice Pack type	WHO/PQS/ E005/IP01.3	WHO/PQS/ E005/IP01.3	WHO/PQS/ E005/IP01.3
Volume of Ice Packs	0.60 Litres	0.40 Litres	0.60 Litres
Size of Ice Packs	190 (W) x 121 (D) x 35 (H) mm	165 (W) x 95 (D) x 33 (H) mm	190 (W) x 121 (D) x 35 (H) mm
Confirming to WHO specifications Cold Life Requirement as per WHO at 43° C without opening :	WHO/PQS/E004/VC02-VP.1	WHO/PQS/E004/VC02-VP.1	WHO/PQS/E004/VC02-VP.1
Actual Cold life without opening at 43° C as tested	33 hrs 50 min	34 hrs 30 min	38 hrs. 26 min

PERFORMANCE

**Disclaimer:** Image and accessories shown may differ from the actual equipment. technical specifications are subject to change without any prior notice

# F500 Series CONTINUOUS INKJET PRINTER

Print . Mark . Pack

UNCONVENTIONALLY SIMPLE!

## Key Highlights



Simple **Unipart Ink System**  
with NO lock-out hours



Easy to Replace, combo external  
filter unit up to 2 years of life



Modular design with plug & play  
serviceability



No mess, No spill, quick change  
ink cartridge system



Long Life, High Durable IP55  
rated construction



## NILKAMAL F500 SERIES

The F500 Series Nilkamal printer with **Unipart Ink System**, without lock-in chip, ensures cost efficient utilization. Reliability of operation with robust stainless steel IP55 modular construction, ensuring the printer survive the hardest of environments. It has **Powerful** and Flexible print data options through the network or local scanners with a mistake-proof, plug and play modular design, the F500 series printers eliminate high service skill requirements and makes it **Unconventionally Simple!**

## UNIPART INK SYSTEM

At the heart of the new F500 series is the all-new Unipart Ink System designed using 3D printing technology that gives the printer a modular structure and improves its reliability. A combo external filter fitted to the Unipart Ink System lasts up to two years and lowers the scheduled maintenance costs.



# Modular Structure



A robust yet modular structure makes this inkjet printer easy to use, operate and maintain. A simple design with less serviceable components assures high uptime.

## Combo External Filter

No more replacing the entire Unipart, just to replace the filter.  
**Quick and Easy** with simple tools.



## Modular print head

Modular print head with **armoured conduit** enhances reliable operation and easy maintenance.



Food



Beverage



Wire & Cable



Pharma

# Machine configuration

	F530 Si	F560 Si	F580 pi
Nozzle	70/60 um	70/60/50/40 um	70/60 um
Maximum Vertical Drops	25	34	34
Multi- Language	●	●	●
Traversing Printing	●	●	●
90 Degrees Vertical Printing			●
IP55 Industrial Protection		●	●
Special Counter		●	●
USB Port	●	●	○
Serial Port	○	○	○
Duration Pump for Special Ink		○	●
Ink Recovery Pump	○	○	○
Positive Air Pump	○	○	●
Solvent Flush Pump	●	●	●
Dye Ink	●	●	●
Pigment Ink			●
High Speed Mode		○	○
Umbilical	Lenght: 2700mm Diameter: 21mm Bending Radius: 150mm		
Print Height	1.2-15 mm		
Max Printing Speed	25-320 m/min with 0.417mm print dot interval		
Printing Distance	2-15 mm		
Input System	Standard American Keyboard of WYSIWYG		
Print Font	5x5, 6x5, 7x4, 7x5, 9x7, 9x7 Bold, 11x9, 11x9 Bold, 16x11, 24x16, 32x24		
Operating Range	5-45 Deg C		
User Defined Field	Bar Code, QR Code, Logos, Clock, Counter, Classes, etc		
Electricity	100-240 VAC, 50HZ		
Power	120-150 W		
Net Weight	27kg		
Gross Weight with Complete Package	45kg		

Note: The "●" in the above table stands for "standard" , and the "○" stand for "optional"

Product specification and design are subject to change without prior notice and may vary from those shown

## DIMENSIONS

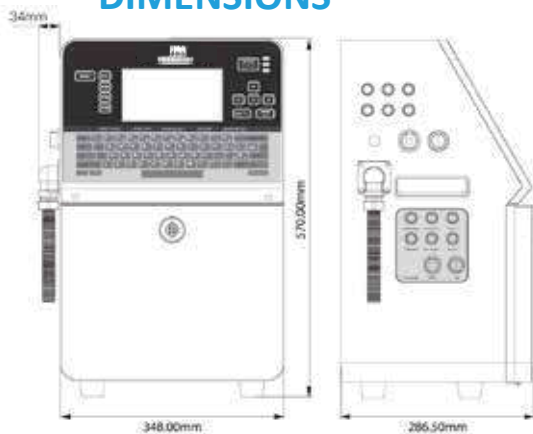

## PRINTHEAD

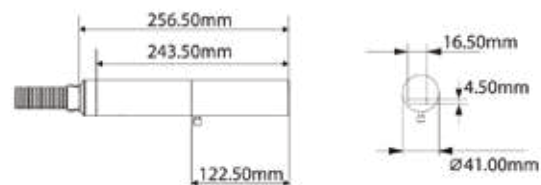

# MOULDED PLASTIC PALLETS

Nilkamal pallets are developed in close association with user industry and technological advances in material handling and storage systems. They meet environmental considerations are proven more economical in the long run, also improving storage and handling systems in the process. Nilkamal plastic pallets are easy to clean and handle and withstand commonly used chemicals, solvents and cleaning agents. This section gives detailed information about our range of Injection Moulded and Roto Moulded Pallets. You will find detailed lists of models, highlighting specific useful information about entry points and recommended mode of usage as well as detailed tabulations about foot prints and other relevant features.



**3 Runner Injection Moulded Pallets - Rack Application**



**9 Leg Injection Moulded Pallets - Floor Application**



**Roto Moulded Pallets - Rack Application**



**AP0606 - Floor Application**



**Spill Pallets**

# PALLET SELECTION CHART

Sr.	Model Suffix	Foot-Print - mm	Roto Molded Pallet			Injection molded Pallets										
			9-leg	3-Runner	Reversible	AP	SP	DP	OW	GMA	GMP	FP	DSP	DPR	EP	
1	0606	660 x 660				●										
2	0707	750 x 750	●	●												
3	0711	720 x 1170		●												
4	8060	800x 600														●
5	0808	800 x 800		●												
6	0810	800 x 1000		●												
7	9065	900 x 650					●									
8	9075	900 x 750	●													
9	0909	900 x 900		●												
10	0912	900 x 1200		●												
11	1006	1000 x 600					●									
12	1008	1000 x 800		●			●									
13	1010	1000 x 1000	●	●		●	●		●				●			
14	1012	1000 x 1200		●		●										
15	1109	1100 x 900														●
16	1111	1100 x 1100		●		●		●	●	●	●	●				●
17	1114	1100 x 1400		●												
18	1197	1120 x 970									●					
19	1108	1130 x 830		●												
20	1198	1140 x 980														
21	1109	1150x 990		●												
22	1208	1200 x 800	●	●		●	●	●			●					●
23	1210	1200 x 1000	●	●		●	●	●	●	●	●	●		●	●	
24	1211	1200 x 1100							●							
25	120105	1200x 1050		●												
26	1212	1200 x 1200	●	●	●	●		●				●		●	●	
27	12510	1250x 1000	●													
28	125125	1250 x 1250	●													
29	127095	1270 x 950								●						
30	127109	1270x 1090								●						
31	1311	1300 x 1100						●					●	●		
32	131088	1310 x 880								●						
33	132110	1320 x 1100								●						
34	1385	1320 x 850		●												
35	1310	1330 x 1070		●												
36	134120	1340 x 1200		●												
37	1411	1400 x 1100		●				●					●			
38	1412	1400x 1200						●								
39	1512	1500x 1200		●				●								
40	1515	1500 x 1500			●		●	●					●			
41	1616	1600 x 1600					●	●								
42	1812	1800 x 1200	●					●								
43	1814	1900 x 950						●								
44	1818	1800 x 1430						●								
45	1995	1800 x 1800						●								

Please decide first about pallet foot-print . Check you need Roto molded pallet or Injection Molded pallet. This chart does not indicate pallet performance. For Roto Molded pallet refer our separate detailed brochure. Before finalizing any design, consider available MHE, Racking system, type of goods. Take Nilkamal advise for Optimizing pallet design & available colour scheme. All details subject to change without notice. We can supply selected foot-print mild steel powder coated pallets, hot dip Galvanized pallets & Wire mesh cage.

# INJECTION MOULDED PALLETS (MODEL : AP - 1210)

• Fail-safe, anti-skid perforated design. • Suitable with all kinds of Material Handling Equipments & all conventional racks like Pallet Storage Systems, Drive-In Rack & Also ASRS Double Deep Racks, Shuttle car etc. • Best for use as returnable pallets with unmatched durability for all purpose heavy industrial applications. • Can withstand heavy point loads and heavy temperature variations • Products are protected from rolling, pitching, yawning, heaving, swaying and surging during crude conventional internal and external handling, inland or ocean transportation. • Truly All Purpose Pallet.



Compatible MHE :	
Equipment	Refer to Page No.
Hand Pallet Truck	43
Electric Pallet Truck	44
Electric Stacker	44
Electric Reach Stacker	45
Electric Reach Truck	45
Forklift	50

Entry for all listed MHE from the 3 runner side. Only flat blade fork equipment ie, Reach Stacker, Reach Truck and Forklifts can enter from the window in the closed side. Also ensure that the forks are spread wide to ensure better stability.



Eliminate the packing material waste, scrap littering around. Use Nilkamal load retaining Lashing Belt & Lashing PP ordinary ropes with Buckles. Save on using Reusable Load Retaining Straps.

Model	Dimensions	Static Load (Kg.)	Dynamic Load (Kg.)	Racking Load (Kg.) Standard PSS	Drive-in Rack Load (Kg.)	W			H		
						h	A	B	h	E	F
AP-1210-HW	1200 X 1000 X 160	6000	1200	1000	1000	110	180	700	70	360	880
AP-1210-HW-SE	1200 X 1000 X 160	6000	1200	1000	1000	110	180	700	70	360	880
AP-1210-HWEP	1200 X 1000 X 160	6000	1200	1000	1000	110	180	700	70	360	880
AP-1210-S8	1200 X 1000 X 150	6000	1250	1000	1000	110	160	700	110	350	850
AP-1210-SL4	1200 X 1000 X 150	3000	1000	600	1000	110	160	700	110	350	850
AP-1210-SW4	1200 X 1000 X 150	3000	1250	400	1000	110	160	700	110	350	850
AP-1210-HWEP-SE	1200 X 1000 X 160	6000	1200	1000	1000	110	180	700	70	360	880
AP-1210-MW	1200 X 1000 X 160	4000	1000	600~750	500~600	110	180	700	70	360	880
AP-1210-MW-SE	1200 X 1000 X 160	4000	1000	600~750	500~600	110	180	700	70	360	880
AP-1210-LW	1200 X 1000 X 160	3000	800	250	N.A.	110	180	700	70	360	880
AP-1210-LW-SE	1200 X 1000 X 160	3000	800	250	N.A.	110	180	700	70	360	880

LW : Low Weight • MW : Medium Weight • HW : Heavy Weight • SE : Safety Edge • EP : Engineering Plastic. Safety Edge is for protection of crates, cartons, boxes etc. from slipping off during handling. All pallets have standard features of Strapping hook. The advantage of incorporating strapping hook is load gets uniformly distributed over pallet, so bending is reduced & load bearing capacity goes up. If you do not use strapping hook & belt, load bearing capacity goes down.

# INJECTION MOULDED PALLETS (MODEL : SP - 1210)

- Cost effective solutions for all your shop-floor handling, storage & flexible logistics systems in almost all sectors. • Meets general hygiene conditions.
- Suitable to handle with all kinds of Material Handling Equipments.

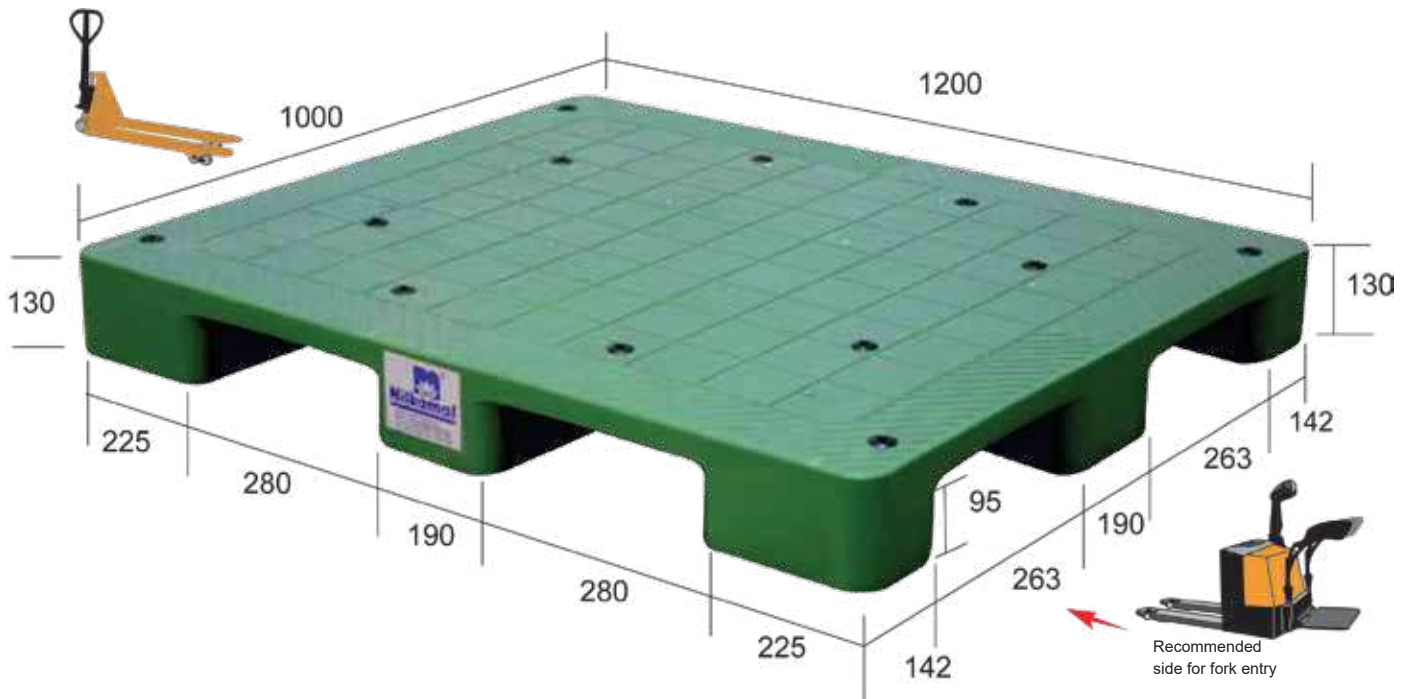

Upside Down

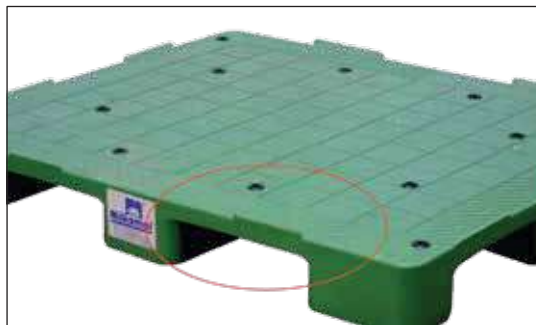

With safety Edge (Optional)

Compatible MHE :	
Equipment	Refer to Page No.
Hydraulic Hand Pallet Truck	43
Electric Pallet Truck	44

Recommend to lift from small side (1000 mm.) with wider spread fork. 9-foot pallet should be uniformly lifted to avoid pallet sagging. Do not throw, shoulder drop on flat deck.



Model	Dimensions	Top Deck	Static Load (Kg.)	Dynamic Load (Kg.)	Racking Load (Kg.)	Flat Deck			Safety Edge		
						h	B	A+B+A	h	F	E+F+E
SP-1210-HW	1200 x 1000 x 130	Flat	3000	1000	N.A.	95	190	716	95	190	750
SP-1210-HW-SE	1200 x 1000 x 130	Flat	3000	1000	N.A.	95	190	716	95	190	750
SP-1210-MW	1200 x 1000 x 130	Flat	2500	750	N.A.	95	190	716	95	190	750
SP-1210-MW-SE	1200 x 1000 x 130	Flat	2500	750	N.A.	95	190	716	95	190	750

HW : Heavy Weight • MW : Medium Weight • SE : Safety Edge. Safety Edge is for protection of crates, cartons, boxes etc. from slipping off during handling.

# INJECTION MOULDED PALLETS (MODEL : AP - 0606)

**2-way, 3-Runner, perforated deck pallet.** Take trials before committing. Reinforced rib structure, suitable to handle with standard Hydraulic Pallet Truck : 550 mm width over fork. This is a special development for Ceramic Tiles.



**Features :**

- Strapping hook for tall stacking above 1 meter
- Can withstand temperature up to 110°C.
- Special grade engineering plastic MOC under development to withstand temperature up to 150°C.

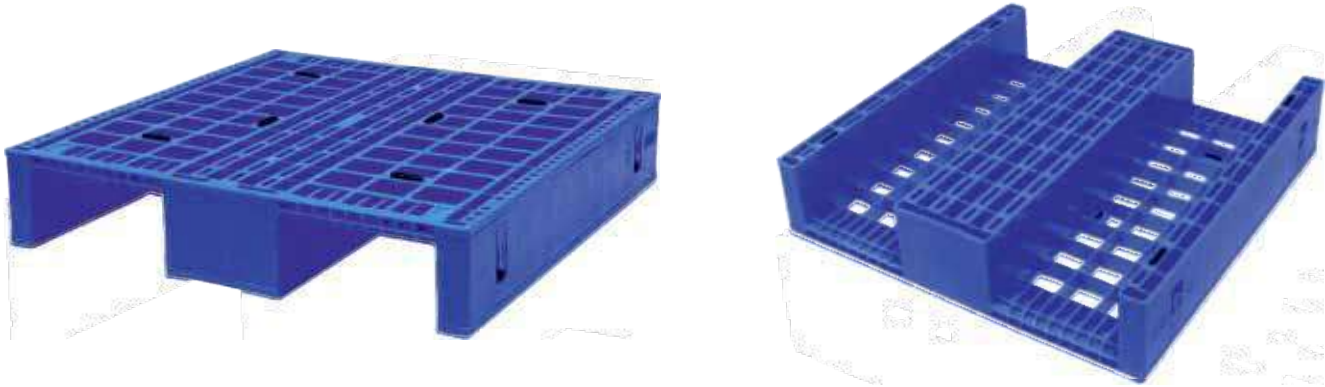

Pails, Jerry Cans, Carbuys, Rocket Cannister Handling



Single Drum Handling



Horizontal Stacking



Vertical Stacking with strapping

Model	Dimensions	Static Load (Kg.)	Dynamic Load (Kg.)	Racking Load (Kg.) Standard PSS	Drive-in Rack Load (Kg.)	Standard Pallet			Drive-in Pallet		
						h	A	B	h	F	E
AP-0606	660 X 660 X 130	1500	750	1000	300	110	180	7007	0	360	880

# INJECTION MOULDED PALLETS

## DP SERIES



DP-1210



DP-1311



MULTI-PURPOSE 4 WAY, ANTI SLIP PERFORATED DECK REVERSIBLE LARGE SIZED PALLETS ESPECIALLY FOR WET FLOORS

Model	Dimensions	Static Load (Kg.)	Dynamic Load (Kg.)	Racking Load (Kg.)	Diagram 1			Diagram 2		
					h	B	A+B+A	h	F	E+F+E
DP-1210CS8	1200 X 1000 X 145	6000	1500	1200	85	300	800	85	300	800
DP-1311	1300 X 1100 X 150	6000	1000	600	100	325	810	100	345	920

## EP SERIES



Model	Dimensions	Static Load (Kg.)	Dynamic Load (Kg.)
EP-1010	1000 X 1000 X 140	1500	800
EP-1109	1100 X 900 X 150	1500	800
EP-1109 3R	1100 X 900 X 145	1500	800
EP-1208	1200 X 800 X 140	2000	1000
EP-1208 3R	1200 X 800 X 145	2000	1000
EP-1210	1200 X 1000 X 140	3000	1000
EP-1210 3R	1200 X 1000 X 145	3000	1000



REAR SIDE

Model	Dimensions	Static Load (Kg.)	Dynamic Load (Kg.)	Racking Load (Kg.)	Diagram 1			Diagram 2		
					h	B	A+B+A	h	F	E+F+E
FP-1210	1200 X 1000 X 150	3000	1000	400	90	190	710	90	190	710
FP-1212	1200 X 1200 X 150	3000	1000	400	90	190	710	90	190	710

# INJECTION MOULDED PALLETS (MODEL : OW-1111)

Injection Molded, Recycle PPCP, Perforated Double Deck, full perimeter 6-Runner, 4-way entry, non-reversible pallet Load Bearing Capacity Static Load : on ground floor Uniformly Distributed Load (UDL) : 2000 kg. for light weight products; Dynamic Load UDL 1000 kg; for light weight products. Racking - not applicable. MHE & HPT: Wider HPT with width over fork of 685 mm recommended for floor use. Forklift Width over Fork Distance should be ideally 700mm.



- Stackable Pallet in Sea Freight containers & floor use for light weight products.
- Stretch Wrap ribs - add tamper evidence to stretch wrap. You can't remove & re-fit stretch wrap, Ribs would tear it while removing.
- Safety Belt hook - Use Strapping belt to make NON-UDL load as UDL load, enhance safety of your product. Enhance Stacking stability during prolonged storage & multiple handling.
- PP Strapping Slot - We recommend low cost PP strapping for small cartons crates, small PET/Glass bottles. Separators & top cap available on request. The in-built provision of PP strapping slot enables multiple handling of these light weight manifold numbers. Small objects do not fall-off the pallet during handling or with little jerk or light hit.
- Top Deck perforation designed anti-slip for products & pallet do not slip off from forks due to special design anti-skid grommets.



## Add to storage density with Stacking Frames

A good idea to increase storage density over a limited storage footprint. Stacking frames should be used when the load on the pallet above cannot impact the goods placed on the lower pallet. The frame takes the load. Stacking frames can be custom built to suit your specific needs, thanks to built in holes in the pallet - an exclusive design feature from Nilkamal.



**Stretch wrap ribs** to show evidence of tampering. The construction of these ribs will tear the stretch wrap film if it is attempted to remove & re-wind



**Slot for PP Straps :** When a number of small goods are loaded on, strapping is useful to secure them against



**Extra Features Perforated :** Top deck to prevent skidding and slippage of stored goods. Also specially designed anti-skid drommets.



**Safety Belt hook** - Use Strapping belt to distribute load uniformly, for safety of your goods. Enhance stacking stability during prolonged storage.



**Safety Edge** - (Optional) as per European standards. Preventive measure against product slippage if pallets tilt



**Hole for stacking frame :** (Optional) A Specially designed hole holds a stacking frame where the load does not impact the contents of the pallet below.

Model	Dimensions (L x B X H) IN MM.	Static Load (kg.)	Dynamic Load (kg.)	Racking Load (kg.) Standard PSS	Drive-in Rack Load (Kg.)	Standard PSS			Drive-in Rack		
						h	B	A+B+A	h	F	E+F+E
OW 1111	1100 X 1100 X 120	2000	800-1100	N.A.	N.A.	70	200	720	70	200	720
OW 1010	1000 X 1000 X 120	2000	800-1000	N.A.	N.A.	90	170	660	90	170	660
OW 1311	1300 X 1100 X 125	2000	800-1000	N.A.	N.A.	75	190	720	75	320	880
OW 1211	1200 X 1100 X 125	2000	800-1000	N.A.	N.A.	75	190	720	75	320	880
OW 1210	1200 X 1000 X 120	2000	800-1000	N.A.	N.A.	90	200	700	90	200	700

# OTHER INJECTION MOLDED PALLETS

Whatever the type of load you have , Nilkamal has the right pallet for you....

NILKAMAL'S pallets are developed in close association with user industry and technological advances in material handling & storage systems. They are proven as viable replacements to conventional pallets. They not only meet environmental and economical considerations but also contribute in improving storage system, product distribution efficiency, product protection and enhanced human safety.

## Special Features :

- Consistent in shape & dimensions
- Light-weight yet strong & durable
- Prevent microbiological growth | Does not absorb water or liquids
- Performance does not degrade by commonly used chemicals, solvents and cleaning agents
- Anti-slip surface prevents slippage of the load in handling and on racks
- Easy to clean and handle.

## Important Information :

- All specifications are subject to change without notice and are approximate
- Pallet load capacity is linked to your product bulk density, package dimensions, layout, MHE & rack design
- The data on pallet load capacity is indicative and based on UDL (Uniformly Distributed Load).
- Racking load stands on the capacity of the pallet rested on length direction
- It is advisable to use and test the sample for all the requirements
- We can supply **RFID embedded pallets based on customer's requirements.**
- All your requirements of M.H.E. (Material Handling / Lifting Equipments) and Storage Rack Systems are now available with Nilkamal - ex-stock.



**GMP - SC** : Stackable Rackable conveyor handling



**FP Series** : Full Parameter Stack, Rack, Used with Pallet Truck



**OW Series** : One Way Stackable



**GMA Series**

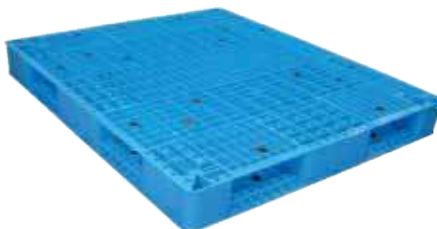

**DP Series** : Reversible Pallet



**DPR Series** : Flat Deck Reversible



**GMP Series** : HACCP, Hygiene Stringent regulation pallet for wipe & clean dust

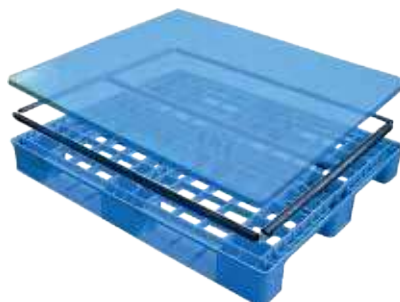

**EP Series** : Export / Nestable

# OTHER PALLETS

## ASSEMBLY SERIES :

**"Make your own size and make your own design pallets."** Other applications are walkways, raised platforms, overhead walkways, Gantry & passage flooring. Top Deck Planks size : 145 x 25 x 2200mm. The length can be cut to any required size. • Bottom plank : 30 x 40 x 2200mm. The length can be cut to any required size.



Top plank & bottom plank can be simply screwed on & fabricated as wooden planks to get required shape & Design.

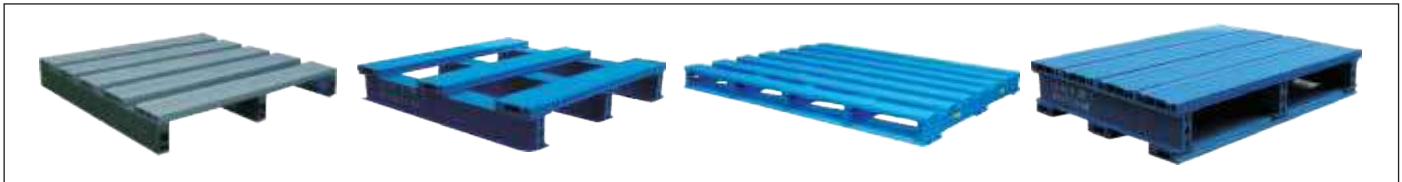

## ANTI-SKID FLOORING PALLETS :

Used for wet floors, shop floors, labs. Tapered FL-1010, used in animal butcheries, stables & cow-sheds (Tabelas)

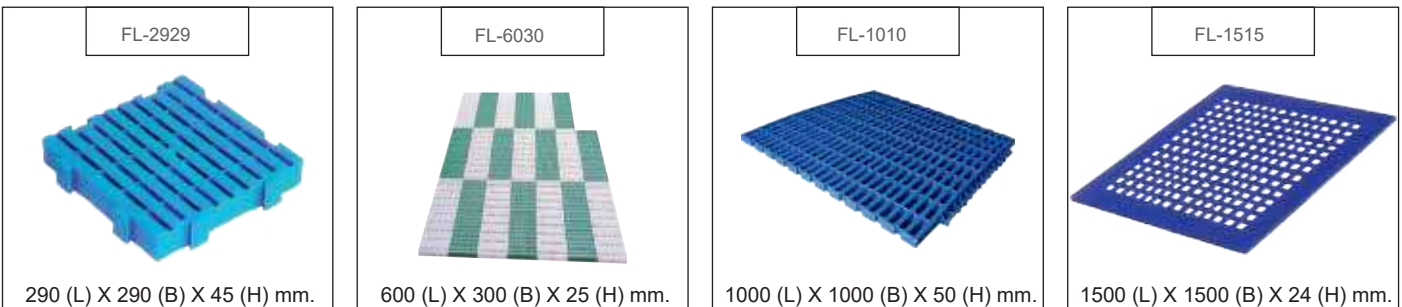

## SCRATCH RESISTANT POWDER COATED SURFACE FINISH PALLETS



## STAINLESS STEEL PALLETS :



## HOT DIP GALVANIZED PALLETS :



# ROTO MOLDED PALLETS

•Hygienic and useful for GMP clean rooms •Environment friendly •Durable and cost effective •Easy to maintain – just wipe and clean. Machine wash and steam cleaning also possible • Resistant to commonly used chemicals •Exclusive Rack lock for locking pallet on standard rack •Wings on Rail for drive-in racking •Hi-end textures available.

**RACK LOCK PALLETS WITH STEEL RE-INFORCEMENT** : No bending even with Point Load. No shifting or slipping of pallets. Enhanced Safety

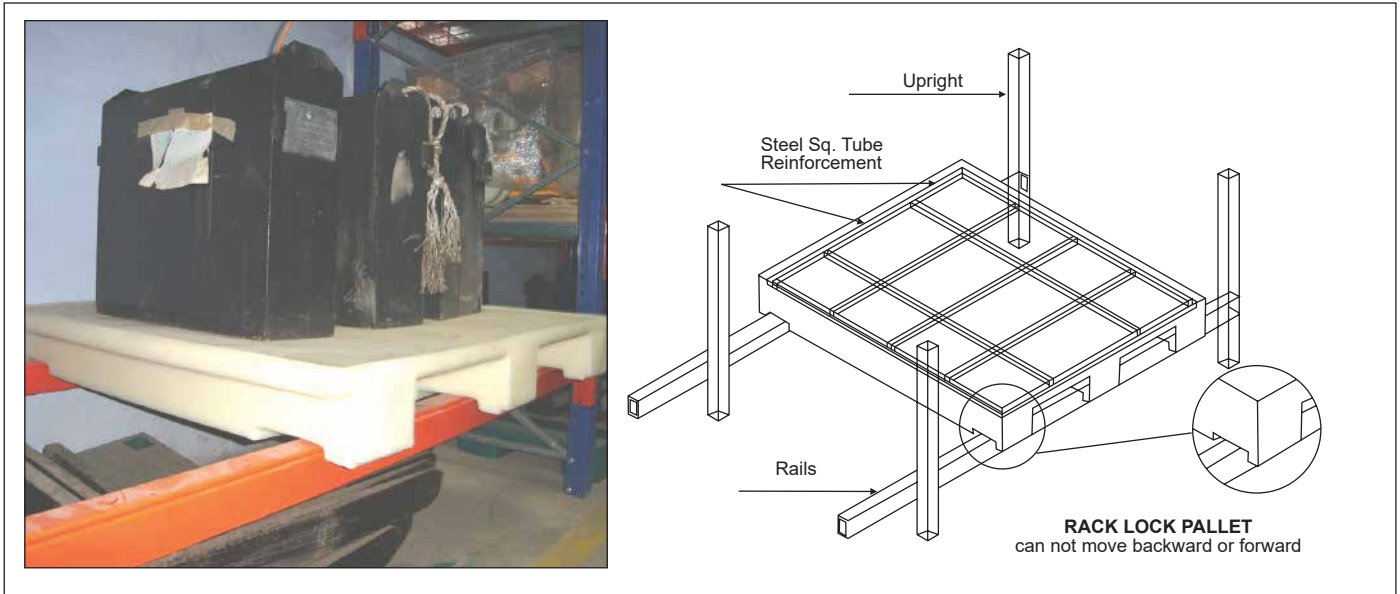

## 3 Runner Pallets : For General Usage On Rack & Floor :

With Rack Lock, Safety Edge & Wing Runners



**RP1212C3RUS1Z1**

1200(L) x 1200(W) x 160(H) MM.

With Rack Lock & Wing Runners



**RP1210F3RUS2**

1200 (L) x 1000 (W) x 150 (H) MM.

With Rack Lock & Flush Runners



**RP0707F3RU3**

750 (L) x 750 (W) x 150 (H) MM.

With Flush Runners



**RP0909F3RUSJ4**

900 (L) x 900 (W) x 150 (H) MM.

With Safety Edge & With Flush Runners



**RP1515DA3RUS6**

1500(L) x 1500(W) x 160(H)MM.

With Rack Lock, Safety Edge & Flush Runners



**RP1010CO3RUS9**

1000 (L) x 1000 (W) x 160 (H) MM.

With Flush Runners



**RPROLL1210F3RUJ4**

1200 (L) x 1000 (W) x 260 (H) MM.

With Rack Lock, With Safety Edge & With 5 Flush Runners



**RP1208P5RUS6**

1200 (L) x 800 (W) x 160 (H) mm.

## 9 Legs Pallets - For Floor Usage

With Kiss-off Bottom, Stacked Leg, Wing Leg, Kiss-off Bottom of Legs



**RP1210F9L51**

1200 (L) x 1000 (W) x 150 (H) MM.

Flat Bottom, Tapered Leg, Flush Leg, Flat Bottom of Legs



**RP1210F9LUS53**

1200 (L) x 1000 (W) x 160 (H) MM.

With Flat Bottom, Round Leg, Flush Leg, Flat Bottom of Legs



**RP1212F9LUS52**

1200 (L) x 1200 (W) x 160 (H) MM.

Flat Bottom, Tapered Leg, Flush Leg, Flat Bottom of Legs



**RP1007CO9LUS53**

1065 (L) x 750 (W) x 170 (H) MM.  
(SPECIAL PALLET FOR PRINTING INDUSTRY)

**Customized Innovations :** Pallets for ASRS, RFID, automated hi-speed multi-tier conveyor & sensor sorting needs special deck design & texture surface. Thanks to in-house software based designing capabilities and further CNC machining facilities, we provide proprietary solutions and which has improved anti-slip property, improved feasibility with robotized handling and improved security and useful life of pallet & other value additions.



Model No : **RP1010P2R3LUSJ4.**  
Dimensions : 1000X1000X150MM • Texture type : PERFORATED.  
Useful for : DAIRIES AND COLD STORAGE FOR AIR CIRCULATION.



Model No : **RP1108C3RUSJ6.**  
Dimensions : 1130 X 830 X 210 MM • Texture type : BIG CHEQUERED.  
Useful for : HEAVY LOAD IN AUTOMOBILE INDUSTRY & OTHER GENERAL PURPOSE.



Model No : **RP1208C3RU3**  
Dimensions : 1200 X 800 X 130 MM.  
Texture type : CHEQUERED TOP WITH HANDLE FOR LIFTING.  
Useful for : STORAGE OF CARTON BOXES FOR LIGHT APPLICATION.



Model No : **RP1208D3RUS3Z1**  
Dimensions : 1200X800X160MM.  
Texture type : DIAMOND TOP WITH STRAPPING SLOT.  
Useful for : CARTONS AND SMALL CONTAINERS.



Model No : **RP1208180B3RUS6.**  
Dimensions : 1215X810X180MM.  
Texture type : BOX TYPE DESIGN. | Useful for : BOXES



Model No : **RP1385C3RUS3Z1**  
Dimensions : 1320 X 850 X 165 MM • Texture type : CHEQUERED DESIGN.  
Useful for : CARTONS, BOXES.

# SPILL PALLETS & DRUM PALLETS

**SPILL CONTAINMENT PALLETS :** Nilkamal's Spill Containment Pallets are an absolute must for food & pharma companies.

Spillage can occur anywhere / any time & can contaminate sensitive food & pharma products or clean rooms, causing huge rejections & recalls. Nilkamal's Spill Containment Pallets are made to international standards and & are an absolute necessity for your pharma or food manufacturing set-up.

## Injection Molded :



Model : **IMPC120L3RSPIL**  
Dimensions : 1330 (L) x 670 (B) x 150 (H) mm.



Model : **IMPC200L3RSPIL**  
Dimensions : 1330 (L) x 670 (B) x 400 (H) mm.



## Roto Molded :



Model : **RMPC100L3RSPIL**  
Dimensions : 1300 (L) x 1300 (B) x 200 (H) mm.



Model : **RP120L3RSPIL2**  
Dimensions : 1400 (L) x 800 (B) x 270 (H) mm.

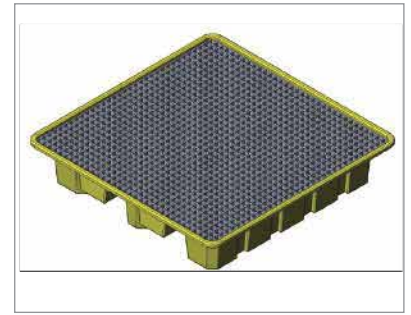

Model : **RP240L3RSPIL4**  
Dimensions : 1400 (L) x 1400 (B) x 270 (H) mm.

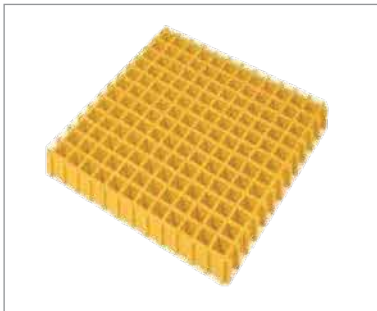

Model : **FRPGR1374MA7YEL**  
Dimensions : 1336 (L) x 728 (B) x 25 (H) mm.



Model : **RMPC525L3RSPIL** • Dimensions : 1300 (L) x 1300 (B) x 575 (H) mm.  
Pallet with lid • Stacking : Ground +2 • Sump capacity : 525 liters



## DRUM PALLETS :



Model : **AP1111SC**  
Dimensions : 1100 (L) x 1100 (W) x 140 (H) mm. sprox.  
Load Bearing : Uniformly Distributed Load  
Static : 3600 kg. • Dynamic : 1200 kg. • Racking : 600 kg.  
Should be handled with Forklift or Pallet truck only.



Model : **DP1212**  
Dimensions : 1200 (L) x 1200 (W) x 150 (H) mm. sprox.  
Load Bearing : Uniformly Distributed Load  
Static : 6000 kg. • Dynamic : 1500 kg. • Racking : 1000 - 1500 kg.  
Should be handled with Forklift only.



# KIT CRATES

**NILKAMAL** introduces KIT CRATE with Zero Defects –Best in class Quality. Safe, Clean Ergonomic Work Environment. No “non-value” duplication or added work. Communication, Standardization, Visual work place with provision for continuous improvement. Larger the load handled, the lower the cost per unit handled.

## SIDE WALLS FOLDING KIT CRATES :



Model : **CH1210590**  
Outside Dimensions : 1200 (L) x 1000 (B) x 590 (H)



Model : **CH1210975 (Folding Kit Crate with Lid)**  
Outside Dimensions : 1200 (L) x 1000 (B) x 975 (H)



### Step Wise Assembling Process



Model : **CH1210800** Outside Dimensions : 1200 (L) x 1000 (B) x 800 (H) All four side walls fold on base pallet, 2-way fork entry, 2-Bottom Runner Design.



Model	Outer Dimensions
CH12105902RGRY	1200(L) x 1000(B) x 590(H) MM
CH1210975	1200(L) x 1000(B) x 590(H) MM
CH1210800	1200(L) x 1000(B) x 975(H) MM
CH1210740	1200(L) x 1000(B) x 800(H) MM
CH1210975LD2R	1200(L) x 1000(B) x 740(H) MM
LID1210GRY	1200(L) x 1000(B) x 975(H) MM

Available with solid closed walls and perforated walls and 2 way entry, 3 runner design, suitable for racking & stacking.

# ROLLING EQUIPMENTS

Nilkamal offers a range of **Platform Hand Trucks** for easy manual movement of goods inside the factory or warehouse premises. Designed for ease of use, these platform trolleys and pallets are ideal material handling equipment used in many industries, warehouses, shopping malls, airports, hotels – the list is practically endless as everyone seems to discover a use for these. Sturdy construction, these Platform Hand Trucks are durable and easy to push or pull, thus enhancing your workforce's productivity.

PLATFORM HAND TRUCK



Model : PH100 • Capacity : 100 kgs.

ZINC CHROME PLATFORM HAND TRUCK



Model : PH350ZNCR • Capacity : 350 kgs.

STAINLESS STEEL PLATFORM TRUCK



Model : PH150SS • Capacity : 150 kgs.



MINERAL WATER SACK TROLLEY



Model : SCT250AL- 7 • Capacity : 250 kgs.

WHEEL BARROW



Model : WB220 • Capacity : 220 kgs.

MULTI PURPOSE SERVICE TROLLEY



Model : SRT300 • Capacity : 300 kgs.

## HOT DIP GALVANIZED METALLIC ROLL CAGE :



Model : MHDRC1170170 • Capacity : 500 kgs.



Model : MHDRC10811550 • Capacity : 500 kgs.



# METALLIC CAGES & BULK CONTAINERS

**METALLIC CAGES :** Nilkamal Full View Foldable Galvanized Metal Wire Cage is the clear choice for better bulk material handling, storage, JIT closed loop returnable systems. • Rustproof • Durable • No Fire hazard • Can withstand all kinds of environments • Virtually indestructible • Low weight to load ratio as containers are lighter • No performances sacrifice in cold, hot, sultry or highly corrosive atmosphere and salt spray conditions for ocean transportation



Model	External Dimensions	Internal Dimensions	Wire Mesh	UDL Capacity	Filled Stack
MWC8060640-6C-4L	800 X 600 X 640 mm. 32" X 24" X 25"	760 X 560 X 510 mm. 30" X 22" X 20"	C = 50 X 50 mm.	800 kg.	1 + 4
MWC1080840-6C-4L	1000 X 800 X 840 mm. 40" X 32" X 33"	960 X 760 X 710 mm. 38" X 30" X 28"	C = 50 X 50 mm.	1200 kg.	1 + 4
MWC1210890-6C-4L	1200 X 1000 X 890 mm. 48" X 40" X 35"	1160 X 960 X 760 mm. 46" X 38" X 30"	C = 50 X 50 mm.	1500 kg.	1 + 4
MWC12101125-5E-4L-2R	1200 X 1000 X 1125 mm. 48" X 40" X 45"	1160 X 960 X 985 mm. 46" X 38" X 40"	E = 100 X 100 mm.	800 kg.	1 + 3
MWC12101125-6C-4L-2R	1200 X 1000 X 1125 mm. 48" X 40" X 45"	1160 X 960 X 985 mm. 46" X 38" X 40"	C = 50 X 50 mm.	1200 kg.	1 + 3

**MWC :** Metallic Wire Cages • **L :** Legs • **R :** Runners • **UDL :** Uniformly Distributed Load • **Gauge :** Wire Thickness • **A, B, C, D, E & F** stands for Wire Mesh Pit





**Powder Coated Metallic Bulk Cages (MBC)**  
**Model No. : MBC1080750-2R / MBC1210750-2R**  
External Dimensions : 1000 x 800 x 750 mm. / 1200 x 1000 x 750 mm.  
Internal Dimensions : 930 x 730 x 605 mm. / 1140 x 940 x 640 mm.  
Capacity : 1000 kg. / 1200 kg. • Stacking : 1 + 4 / 1 + 4

## BULK CONTAINERS :

- Reusable industrial container designed for the transport and storage of bulk liquid and granulate substances (e.g. chemicals, food ingredients, solvents, pharmaceuticals, etc).
- Stackable containers with a metal frame and a metal pallet base designed to be moved using a forklift or a pallet truck.
- Built-in tap at the base through which the contents can be poured out into smaller containers or to which a hose can be attached.

### Advantages :

- Transport more material in the same area than round drums and far more than might be shipped in the same space if packaged in consumer packs.
- The manufacturer/processor of a product can bulk package a product at one location and ship to another location at a reasonably low cost where it is subsequently packaged in final appropriate consumer packs for retail distribution.



Drainage valve for attaching pipe or tap



Drainage valve with pipe or tap

Nilkamal is the only company in India, which offers complete solutions for material handling under one roof. Our main features & USP are :  
• Latest Technology ahead of time • Ex-stock Availability • All products conform to European norms (CE). You will find detailed lists of models and respective versions along with their capacities and lift heights and their usage areas that would help you make your buying choices easier.



**Nilkamal**

**MATERIAL HANDLING**



# ING EQUIPMENTS

# SELECTOR CHART

Model	Multi Purpose equipment for Vertical and Horizontal movement of goods	Dock Work	Horizontal Transport	Narrow Aisle Rack Storage	Very Narrow Aisle Rack Storage	Order Picking	Shelving	Aerial Work	Multi Level goods movement
<b>Manual Range</b>									
NK25		✓	✓						
NKLP10		✓	✓						
NKSS25		✓	✓						
NKPRV10			✓						
NKWS20			✓						
NKSH10			✓						
NKSLT500 / NKSLT1500							✓		
NKSLT350 / NKSLT680							✓		
NKDT03			✓						
NKMS1016 / NKMS1025 / NKMS1516				✓					
NKMSA1016 / NKMSA1516				✓					
NKYTD35			✓						
NKSESIII1030 / NKSESIII1530				✓					
<b>Electric Range</b>									
NKEPT22 (AC)		✓	✓			✓			
NKES				✓					
NKRT				✓					
NKERS1545				✓					
NKCBF1032			✓	✓					
NKVOP0345						✓	✓		
NKTT4-0 - TA / NKTT60-TA			✓						
NKTT30			✓						
NKTTZ40			✓						
NKTTZ60									
Articulated Forklift					✓				
VNA - Man Up					✓	✓	✓		
<b>Electric Cart Range</b>									
NKGC2 / 4 / 6 / 8			✓						
<b>Work Platform Range</b>									
NKMWP120								✓	
NKAMWP8115								✓	
NKJCPT1212DC								✓	
NKMMSL39 (MINI)								✓	
<b>Loading Equipment Range</b>									
NKDL10		✓							
NKLT01 / 02 / 03 / 05 / 10									✓
NKSS 10 / 15									✓
NKMD10		✓							
<b>Forklift Range</b>									
NK20D / NK30D / NK50D / NK80D / NK100D	✓	✓	✓						
NK20LPG / NK30LPG	✓	✓	✓						
NK15E3W	✓	✓	✓						
NK15E / NK25E / NK30E / NK50E	✓	✓	✓						

# MANUAL RANGE

## HAND PALLET TRUCK WITH BRAKE SYSTEM



**HYDRAULIC HAND PALLET TRUCK**  
Model : NK25 • Capacity (kg) : 2500



**HAND PALLET TRUCK WITH BRAKE SYSTEM**  
Model : NK25B  
Capacity (kg) : 2500



**ROUGH TERRAIN HAND PALLET TRUCK**  
Model : NKR-TERRAIN15YEL  
Capacity (kg) : 1500



**LOW PROFILE PALLET TRUCK**  
Model : NKLP10 • Capacity (kg) : 1000



**PAPER ROLL VERSION PALLET TRUCK**  
Model : NKPRV10  
Capacity (kg) : 1000



**STAINLESS STEEL PALLET TRUCK**  
Model : NKSS25 • Capacity (kg) : 2500



**SCISSOR HAND PALLET TRUCK**  
Model : NKSH10  
Capacity (kg) : 1000

### SCISSOR LIFT TABLES



Model : NKSLT500 / NKSLT1500  
Capacity (kg) : 500 / 1500  
Lift Height (mm) : 900 / 1000



**WEIGHING SCALE PALLET TRUCK**  
Model : NKWS20 • Capacity (kg) : 2000



**SCISSOR HAND PALLET TRUCK WITH POWER**  
Model : NKSH10P  
Capacity (kg) : 1000



Model : NKSLT350 / NKSLT680  
Capacity (kg) : 350 / 680  
Lift Height (mm) : 1300 / 1500



Model : NKMS1016 / NKMS1516 / NKMS1025  
NKMSA1016 / NKMSA1516  
**MANUAL STACKER**  
Capacity (kg) : 1000 / 1500  
Lift Height (mm) : 1600 / 2500



Model : NKSES1030 / NKSES1630  
**SEMI ELECTRIC STACKER**  
Capacity (kg) : 1000 / 1500  
Lift Height (mm) : 3000



# ELECTRIC RANGE

## ELECTRIC PALLET TRUCK (AC)



Model : **NKEPT22(AC)**  
Capacity (kg) : 2200 • Lift Height (mm.) : 205



## ELECTRIC STACKER (AC)



Model : **NKES1232 / 1529 / 1536 / 1546 / 1560 / 1563**  
Capacity (kg) : 1200 & 1500 • Lift Height (mm) : 2900 to 6300



### PALLET COMPATIBILITY FOR THE BOTH ABOVE MODELS



3 runner pallet : 2 way entry



9 leg pallet : 4 way entry

# ELECTRIC RANGE

## ELECTRIC REACH STACKER



Model : **NKERSZ1545 / 1555**  
Capacity (kg) : **1500** • Maximum Lift Height (mm) : **5500**



## ELECTRIC REACH TRUCK (Also Available On Long Term Rent)



Model : **NKRT**  
Capacity (kg) : **1600 & 2000** \* Lift Height (mm) : **6500 to 8500**



### PALLET COMPATIBILITY FOR THE BOTH ABOVE MODELS



# ELECTRIC RANGE



**SIT-ON TOW TRACTOR**  
Model : NKTT30 • Capacity (kg.) : 3000



**STAND-ON TOW TRACTOR**  
Model : NKTTZ40/60 • Capacity (kg.) : 4000 / 6000

# VERTICAL ORDER PICKER



Model : NKVOP0345  
Capacity (kg) : 300  
Platform Height (mm) : 4500



# WORK PLATFORM RANGE

## MINI MOBILE SCISSOR LIFTS



Model : **NKMMSL39 (MINI)**  
Capacity (kg) : **240**  
Platform Height (mm.) : **3900**



Model : **NKSPABL**  
Capacity (kg) : **230**  
Platform Height (mm.) : **14000**

## SELF PROPELLED AERIAL WORK PLATFORM



Model : **NKJCPT1212DC**  
Capacity (kg) : **320**  
Platform Height (mm) : **10,000**

## MANUAL AERIAL WORK PLATFORM



Model : **NKMWP120**  
Capacity (kg) : **200**  
Platform Height (mm.) : **12000**

# LOAD EQUIPMENTS RANGE

## DOCK LEVELER



Model : NKDL10 • Capacity (kg) : 10000

## LIFT TABLE



Model : NKLT01/ 02 / 03 / 05 / 10 • Capacity (kg) : Up to 10000 (Customised)



## STATIONERY STACKER



Model : NKSS 10 / 15  
Capacity (kg.) : 1000 / 1500  
Customised



## MOBILE DOCK



Model : NKMD10 • Capacity (kg) : 10000 • Size (mm.) : 11300 (L) X 2100 (W) X 1650 (H) max.



# DRUM HANDLING EQUIPMENT RANGE

## DRUM LOADER



Model : **NKDT03** • Capacity (kg) : **300**

## PARROT BEAK ATTACHMENT FOR FORKLIFT TRUCK



Close-up of the drum being lifted

Model : **PARROTBK-1DRUM**



## MANUAL DRUM STACKER



Model : **NKYTD35**  
Capacity (kg) : **350** • Lift Height (mm) : **1945**

# DIESEL FORKLIFT RANGE

## 2 TON / 3 TON



Model : NK20D / NK30D • Capacity (kg) : 2000 / 3000 • Lift Height upto (mm.) : 6000 • Mast : 2 Stage / 2 Stage FFL / 3 Stage FFL

## 5 TON



Model : NK50D • Capacity (kg) : 5000 • Lift Height upto (mm.) : 6000 • Mast : 2 Stage / 2 Stage FFL / 3 Stage FFL

## 10 TON



Model : NK100D • Capacity (kg) : 10000  
Lift Height upto (mm.) : 6000 • Mast : 2 Stage / 2 Stage FFL / 3 Stage FFL

## 16 TON



Model : NK1600D • Capacity (kg) : 16000  
Lift Height upto (mm.) : 6000 • Mast : 2 Stage / 2 Stage FFL / 3 Stage FFL

### PALLET COMPATIBILITY FOR THE BOTH ABOVE MODELS



3 runner pallet : 2 way entry



9 leg pallet : 4 way entry

# LPG FORKLIFT RANGE



Model : **NK20LPG / NK30 LPG** • Capacity upto (kg) : **3000**  
Lift Height upto (mm.) : **6000**  
Mast : **2 Stage / 2 Stage FFL / 3 Stage FFL**



# ELECTRIC FORKLIFT RANGE

## 1 TON ELECTRIC FORKLIFT



Model : **NKCBFL1032FFL**  
Capacity (kg) : **1000** • Lift Height (mm.) : **3200**

## 3 WHEEL ELECTRIC FORKLIFT



Model : **NK15E3W**  
Capacity (kg) : **1500** • Lift Height up to (mm.) : **6000**

## 4 WHEEL ELECTRIC FORKLIFT



Model : **NK15E / NK25E / NK30E / NK50E**  
Capacity upto (kg) : **5000** • Lift Height upto (mm.) : **6000**  
Mast : **2 Stage / 2 Stage FFL / 3 Stage FFL** • Drive Option : **DC / AC**





# SPECIALIZED MATERIAL HANDLING EQUIPMENTS

## NILKAMAL ARTICULATED FORKLIFT

### Also Available On Long Term Rent

- Reduces aisle widths & increases storage space
- Increases storage space by up to 50%
- Enables a dramatic reduction of working aisle widths
- Cut warehousing costs
- The 2-in-1 machine - Reach Truck and counterbalance forklift in one machine
- Lift capacities of up to 2.5 t
- Electric and LPG powered models



**POWERFUL**

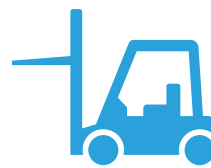

**VERSATILE**



**RELIABLE**

## KEY FEATURES

Increase Your Storage Capacity by up to 200% against a Forklift truck

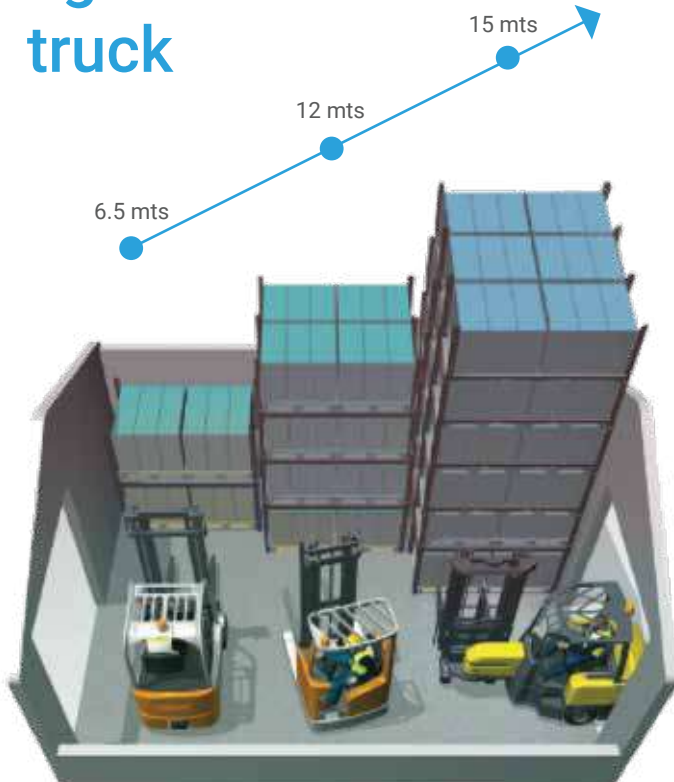

Lift Heights Up to 15mts



Front-Wheel-Drive Equipment with Low Running Costs

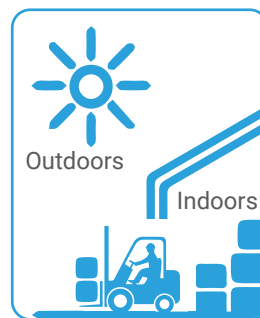

Can Be Operated



Warranty As Standard

# PRODUCT RANGE



## AC Electric Articulated Forklift

- Quick & easy battery removal.
- AC Traction motor (19.5kW)
- A choice of 80V / 400/500amp-hour capacity batteries.
- Ergonomically designed operator's cab.
- Reduced energy consumption.



## Cold Store Articulated Forklift

- Heated cab windows, which eliminate the build up of condensation when driving between different temperatures in a building.
- Designated areas in the cab for use of a barcode scanner.
- Low-energy LED work lights as standard work upto-30 Degrees centigrade.





- Lifts 900 kgs. up to a massive 12.4 meters.
- Mast equipped with camera to guide positioning of pallet
- Can operate in an aisle width as narrow as 2.1 meters.

# SPECIALIZED MATERIAL HANDLING EQUIPMENTS

## THE CONTAINERS & OVERSIZED LOADS HANDLING SPECIALIST



Maximise your Order Picking Efficiency!

**Magaziner Man-Up Turret Trucks** meet the rigorous industry standards, and are also flexible to meet the space and material transport requirements of the individual customer. Compact, powerful, manoeuvrable – and above all adaptable to the customer's specific environment. Magaziner Man-Up Turret Trucks, from Magaziner Lager- & Fördertechnik, **Germany**. The perfect solution for unit load storage and individual article order selection. Since the operator rides up with the load to the desired storage location, he is afforded an equally good view of the load and its rack destination. With a minimum frame width of 1.000 mm and a maximum lift height of 9 mtrs. to 17 mtrs, the Magaziner EK series offers the optimum space utilization. Capacities range from 1.1 tons to 1.5 tons.

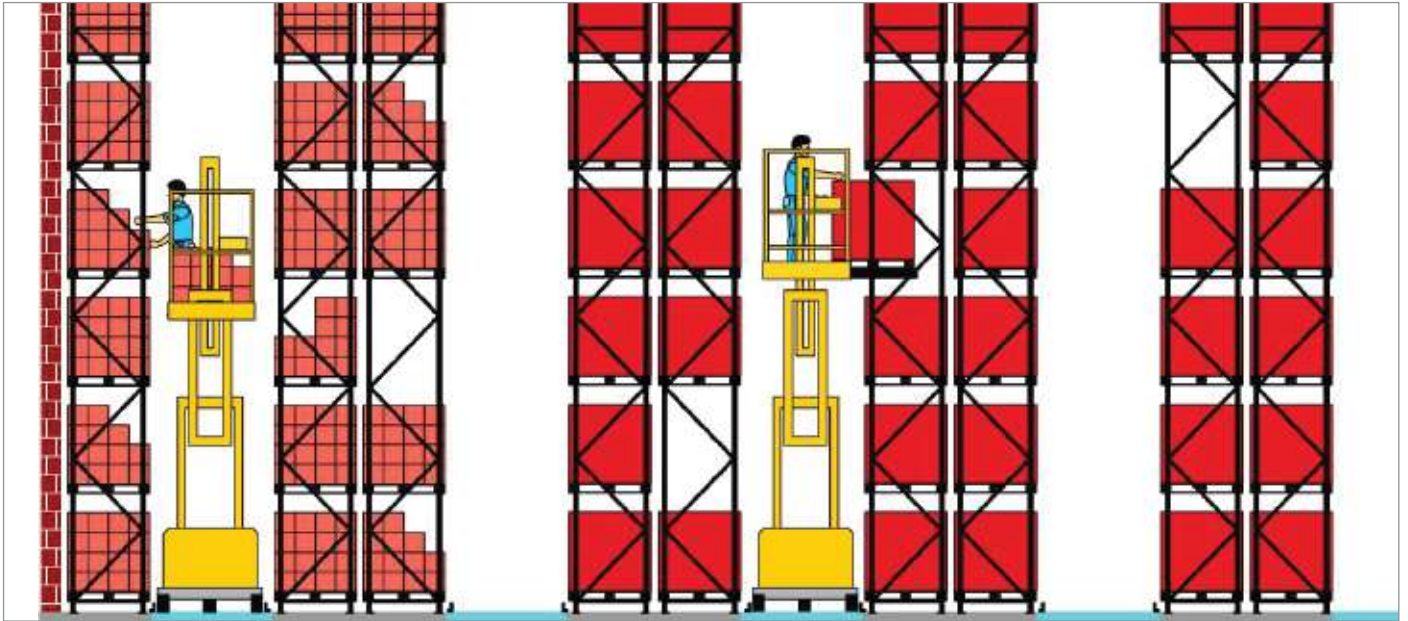

MAN-UP TURRET TRUCKS (Very Narrow Aisle - V.N.A.) (7 Models available) • Lift height up to : 9000 mm.-170000 mm. • Lift Capacities up to : 1100-2000 kg.





**Nilkamal Hands free Hand Wash Station (HWS)** is a simple and affordable solution to keep your facility protected.

The HWS is **Operated by foot peddle for both sanitizer and water tap**, ensuring clean hands without touching any surface. Supplied as a fully knock down assembly, the unit is easy to assemble and flexible to move.



Sanitize hands without touching – COVID ready



Big 80L water tank sufficient for more than 100 washes



Wide 19 inch Basin



Simple and easy to install

**MODEL : HWSFPSBV1**

## FEATURES

- Foot paddle operated sanitizer and water tap
- Knockdown assembly, Easy to install and transport
- MS Powder coated metal stand
- Self and Easy installation guide

## DIMENSIONS

500 (L) x 810(w) x 1290(H)

## SPECIFICATIONS

- Up to 100 Hand washes per tank refill
- 80 L Tank capacity
- 19 Inch wide Basin

# INNOVATIVE STORAGE SYSTEMS :

Nilkamal is a leading manufacturer of different types of storage systems in steel having state of art manufacturing facilities . We follow European standards, also have in-house structural analysis capabilities. We make wide range of racking and shelving systems, from simple to tall ASRS racking up to 32 meters height.



Pallet Storage Systems (PSS)



Universal Storage Systems (USS)



Mezzanine Storage Systems

# UNIVERSAL STORAGE SYSTEMS (USS)

- Cost effective installation.
- Bolt together assembly.
- Easy to mount.
- Also ideal as storage for archives.
- Increased load capacity due to corner plates.
- Panels can be easily re-adjusted on a 25 mm. pitch.
- Extension bays can be added whenever required.
- Very good overview due to clear product presentation.
- More storage capacity on less floor space.

**Angled upright**  
with integrated base plates  
Finish : **Epoxy-coated**

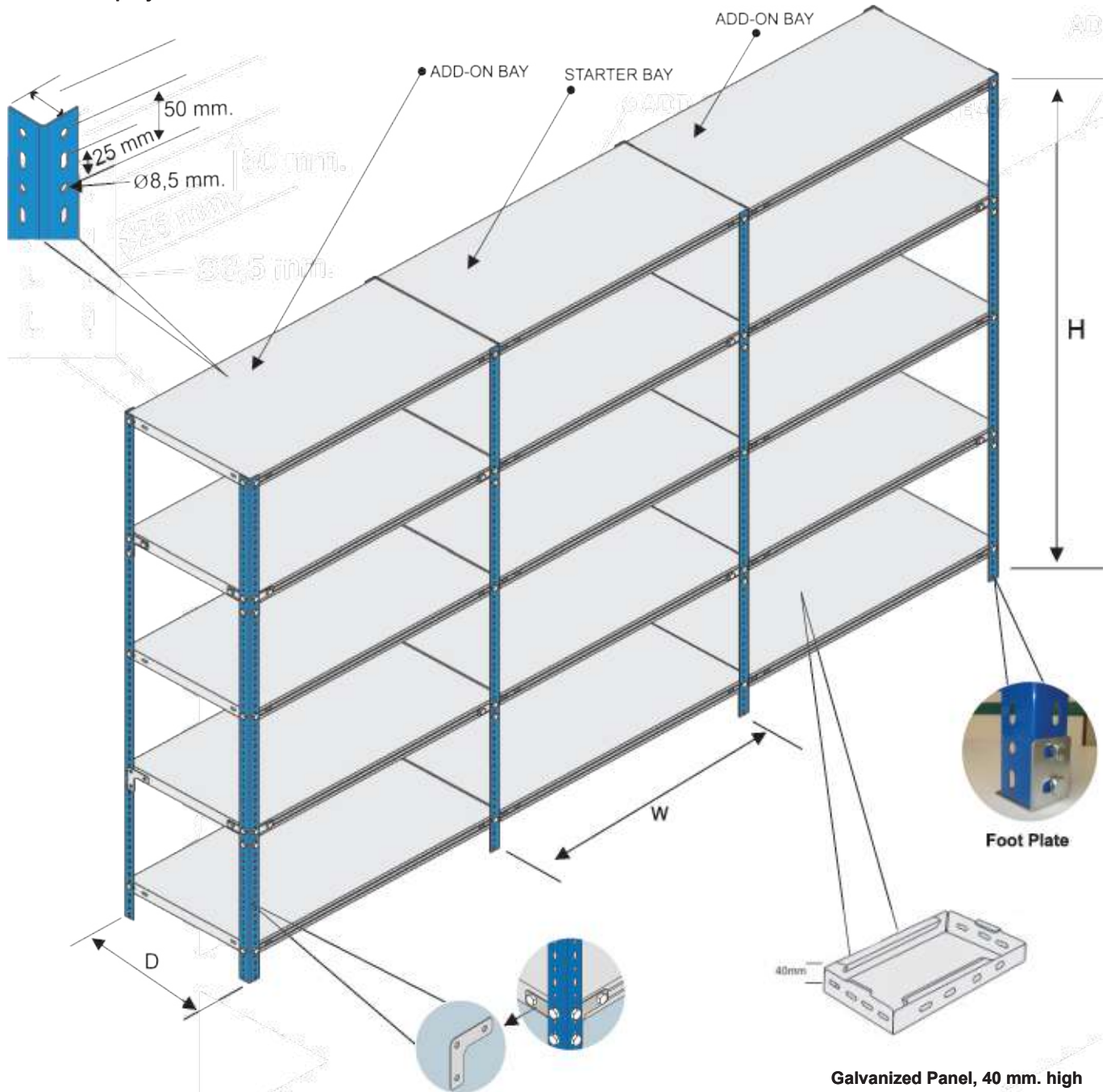

**Galvanized Corner Plate**  
suited for all system lengths  
and depths, fixing material  
included

**Galvanized Panel, 40 mm. high**  
manufactured from steel sheet ;  
accepts upto 150 kgs. uniformly  
distributed load (U.D.L.) due to  
**Unique Ten Bend Construction**

Compatible MHE :  
Trolley (Refer to Page No. 44)

# OUR INSTALLATIONS

## General Advantages :

- Quick and easy to assemble, mount & cost-effective installation
- Economical in long run
- Also ideal as storage for archives
- More storage capacity on less floor space
- Increased load capacity due to corner plates
- Direct access to all references
- Very good overview due to clear product presentation
- Can be integrated into almost any storage environment
- Platforms can be conveniently re-adjusted on a 25 mm pitch
- Extension bays can be added whenever required



# UNIVERSAL STORAGE SYSTEM WITH FLEXIBLE PARTITIONS

The One Product for your Non-Standard Storage Needs! Introducing a Universal Storage System with total flexibility - The Flexi-Rack. With flexible partitions and multi-slotted panels and front stopper strips, the Flexi-Rack is the perfect solution for well segregated storage of nut-bolts, tools and small components. Slotted uprights allow for adjustable levels, so you can adjust height between any two levels to your requirement. Similarly, the panels have multiple slots to take in vertical separators, so the storage space can be adjusted horizontally too. The Flexi-Rack also takes front stopper strips, thus providing security against slippage or spillover for the contents stored.



**Just adjust the flexi way...!!!** : Slotted uprights allow Flexibility to adjust levels. Slotted panels allow Flexibility to adjust horizontal space too !



**Store. Stop spilling over...!!** : Front stopper strips hold back the contents of the storage partitions from spilling over.

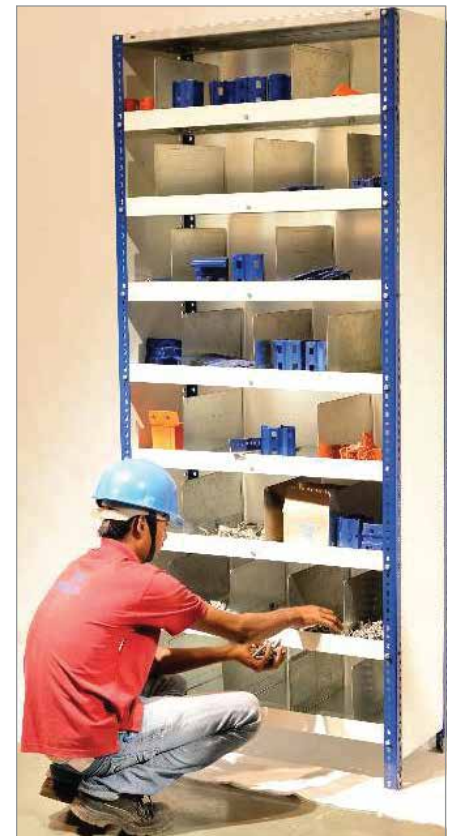

# LONG SPAN SHELVING SYSTEM (LSS)

Long Span Shelving (LSS) is a product used for storing light and medium heavy goods, ranging from 150 kgs to 600 kgs. Ideal for products longer than 1300 mm and load per level greater than 200kgs. Thus the product fits in the intermediate category between the Universal Storage System (USS) and Pallet Storage System (PSS). Euro Pallets (1000 x 800mm) can be stored under the bottom level when the span is 2300mm.

Long span shelving can be used to store virtually anything, like :

- Crates • Boxes • Rolls • Files • Packets • Corrugated boxes • Paint cans
- The list can go on almost endlessly, for products between the range of applicable size and weight



Series	Frame height	Loading Levels	Shelving Depth	Beam width / Load per level
Light	2000 mm	4	600	1500 mm / 500 kg
			800	1800 mm / 400 kg
			1000	2400 mm / 325 kg
Light	2500 mm	5	600	1500 mm / 500 kg
			800	1800 mm / 400 kg
			1000	2400 mm / 325 kg
Light	3000 mm	6	600	1500 mm / 500 kg
			800	1800 mm / 400 kg
			1000	2400 mm / 325 kg
Heavy	2000 mm	4	600	1800 mm / 725 kg
			800	2400 mm / 560kg
			1000	2700 mm / 625 kg
Heavy	2500 mm	5	600	1800 mm / 725 kg
			800	2400 mm / 560kg
			1000	2700 mm / 625 kg
Heavy	3000 mm	6	600	1800 mm / 725 kg
			800	2400 mm / 560 kg
			1000	2700 mm / 625 kg

Compatible MHE : Trolley & Ladder (Refer Page no.44)

# MOBILE COMPACTOR STORAGE SYSTEM

## SAVES MORE SPACE V/S A STATIC STORAGE SYSTEM :

Mobile Compactor System is based on the same components as a static system. Mounted onto light or heavy duty base units which can be moved in parallel direction to each other, the system only requires one aisle to provide access to all items in stock. Depending on the system, storage capacity increases between 100 % and 180 % respectively floor space occupation reduces by up to 50%.

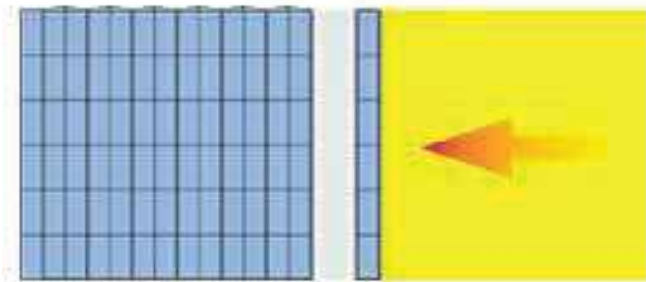

**Configuration:**

2 Static single rows (single sided use) • 6 Static double rows (double sided use)  
 Space requirement : 9,650 x 6,100 mm • Floor space gained : 45 %  
 Floor space utilization : 45 %

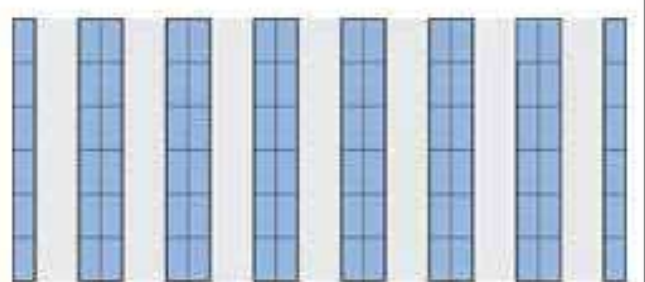

**Configuration:**

2 Static single rows (single sided use) • 6 Mobile double rows (double sided use)  
 Space requirement: 5,300 x 6,100 mm • Floor space gained : 45 %  
 Floor space utilization : 85 %



# MOBILE COMPACTOR STORAGE SYSTEM

Useful for compact storage small spaces, the Mobile Compactor Systems are designed as per the floor space available and for storage and movement. Customer need is fully studied and solutions discussed prior to the final recommendation. The Mobile Compactor Systems are very Compact and provide smooth mobility and an exclusive locking system for the storage security.

**GENERAL ADVANTAGES :**

- Economic storage
- Higher floor surface utilization
- Increased storage capacity
- Improved overview of all product lines on stock
- Reduction of floor space costs as compared to static storage
- Increase of storage capacity of up to 180 % over static solutions
- Good utilization of warehouse volume
- Low cost solution
- Base units accept different types of storage systems
- Up to 50 % less floor space occupied
- Direct access to all items
- Effortless manual operation with push handles or cranks

**SALIENT FEATURES :**

- Custom-made compact system.
- Saves expensive floor space.
- Smooth and easy functioning.
- Prime quality materials and components.
- Locking system is provided for security.
- Built to last.

**USER INDUSTRIES :**

- General Industry
- Pharma & Hospitals
- Libraries & Educational Institutes
- Offices ● Warehousing ● Logistic Companies



# PALLET STORAGE SYSTEM (PSS)

- Multiplication of storage surface by multi-tier or highbay storage systems
- Lower investment costs into real estate and buildings as compared to storage at floor level height
- Suited for a high stock rotation frequency
- Direct access to all bays (reference lines) = easy and convenient order picking
- Fast adaptation to changing reference lines without the need of exchanging your service fleet.

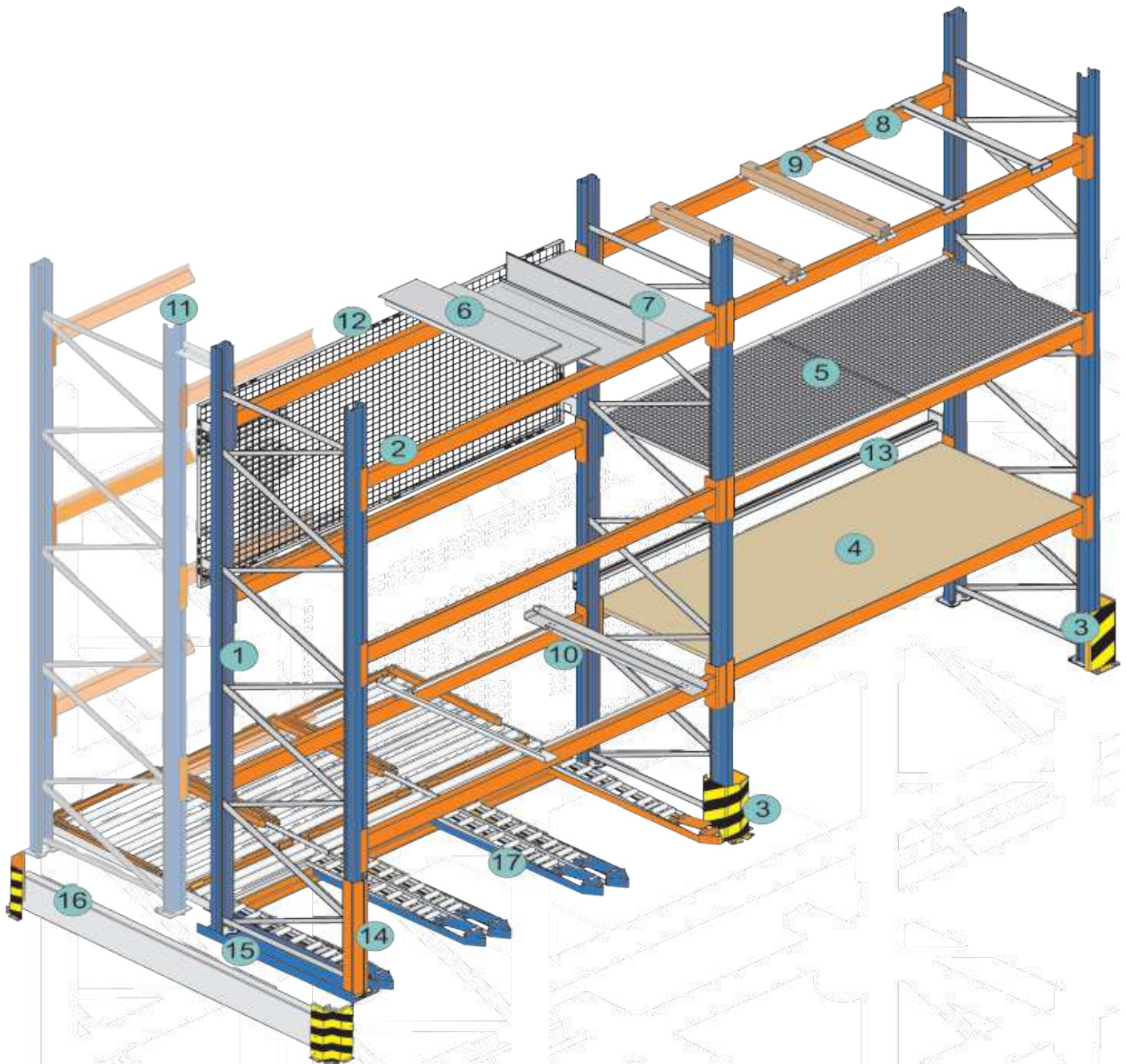

### Index for above schematic drawing

1 : Frame	2 : Beam	11 : Spacer for back-to-back rows
3 : Column Guard	4 : Chipboard Decking	12 : Wire mesh back cladding
5 : Mesh Decking	6 : Drop-over Steel Panels	13 : Back Stopper
7 : Divider	8 : Pallet Support Bar	14 : Upright protector
9 : Pallet Support bar with squared timber block	10 : Support Tray	15 : Load Spreader
		16 : Row guard
		17 : Retro-fit pallet racking : Floor mounted twin track picking unit with load separator for double deep pallet storage, serviced by hand pallet truck.

### Compatible MHE

Equipment	Refer to Page No.
Hand Pallet Truck	49
Electric Stacker	50
Electric Reach Truck	51
Electric Forklift	57
Aisle Master	60

# PALLET STORAGE SYSTEM (PSS)

## Racking Pallet Storage Systems :

The most popular and economical system for pallet storage. Suitable for any type of pallet size and weight to optimize storage. This system can be designed to be serviced with any type of MHE starting from hand pallet trucks at floor level to electric stackers, reach trucks, forklift trucks VNA forklift trucks etc. Advantages : • Cost effective, maximizes available space • Suitable for high-bay warehouses with high storage capacity • Direct access to all the SKU's, easy stock control • Configuration can be easily modified or extended • Lower costs by storing bottom level of pallets on floor



## Pallet Storage Systems with Decking Panels :

Pallet Storage Systems with Decking Panels facilitates storage of non palletized items. Ideal for medium to large sized items that can be handled manually. It is a flexible system for managing variety of items. Higher levels can be added by providing catwalks and multi-tier systems.

Advantages : • Loading levels can be customised based on height of the SKU stored. • Integration possible with suitable material handling equipment for moving material to various levels • Goods Lifts can be added on custom fabricated staircases provided for ease of use. • Wide range of accessories available :



# MEZZANINE STORAGE SYSTEMS

The mezzanine system is the ideal solution for maximum utilization of building height, multiplying the effective surface area available for storage. They are stand-alone structures, easily assembled and adjustable to any space and customer needs. They use a variety of accessories, such as railings, stairs, pallet unloading points, etc. Mezzanines are either rack supported mezzanines with racks making up the ground level or pillar supported mezzanine.

**Advantages :**

- Boltless assembly of all basic components • Full length frames - no joining plates required
- Stiffening beams & additional cross bracing provide for a high load capacity & give structural safety to all bays
- Boltless adjustment of all platforms allows flexible positioning of levels • Safe & convenient stairways secured by railing
- Useful equipment and accessories • Galvanised surface finish (Epoxy coating upon request)

**Pillar Supported Mezzanines :**



**Rack Supported Mezzanines :**



**Compatible MHE for both :**

Trolley	Hand Pallet Truck	Electric Stacker	Electric Reach Truck	Electric Forklift
44	49	50	51	57

# OUR INSTALLATIONS

**Pillar Supported Mezzanine :**



**Rack Supported Mezzanines :**

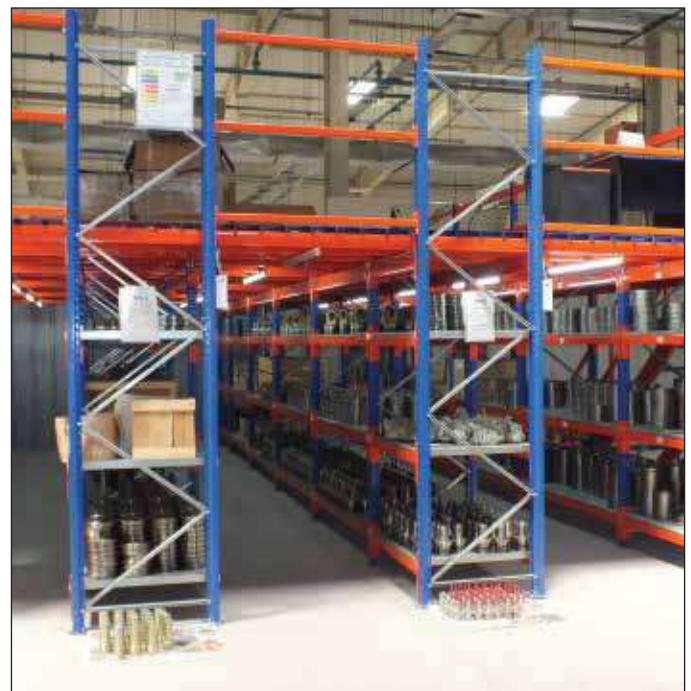

# MULTI-TIER STORAGE SYSTEM

The Multi Tier Storage System is the ideal solution for manual storage where available space is limited. This storage system is selective, allows direct access to all references stored; and is adaptable to any type of unit load. This storage system gives best utilization of height by creating different aisle levels which are accessed by means of stairs. The Multi Tier Storage System is shelving built into two or more levels. The bottom shelving supports the upper levels. The uprights are heavy duty in order to bear the loads from the upper levels. Multi Tiers are often used where the storage of many articles is required.

- Advantages :**
- Utilisation of storage volume can be increased by up to 100%
  - High degree of floor surface utilisation
  - Simultaneous under picking on several tiers
  - Additional floor space is gained for storage & assembly

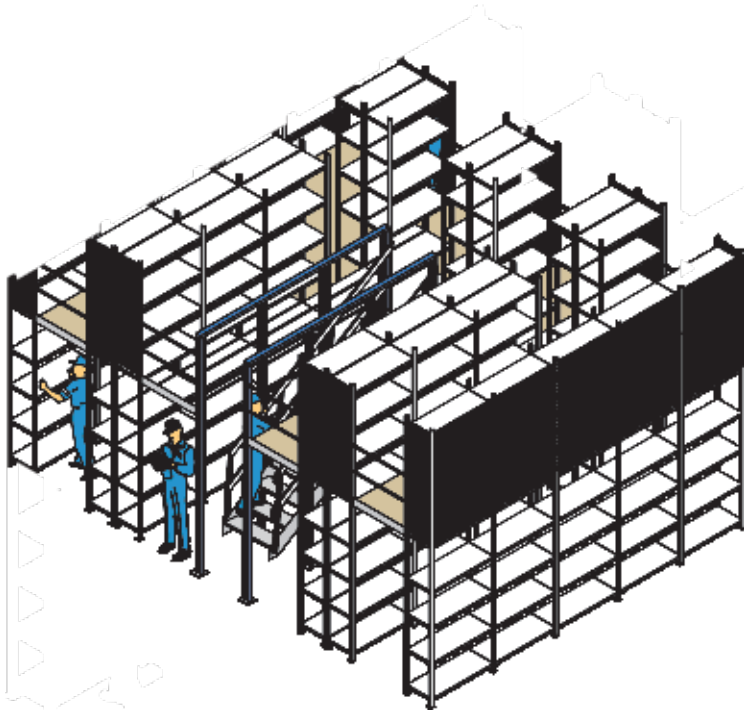

Movement of goods inside a Multi Tier Storage System is either manual or assisted by trolleys or even hand pallet trucks, depending on the aisle width of the system. Goods can be moved to higher levels either by Goods lift, carried up stairs (G+1) or to specially configured pallet loading locations on respective levels with suitable MHE such as :

Equipment	Refer to Page No.
Trolley	44
Hand Pallet Truck	49
Electric Stacker	50
Electric Reach Truck	51
Electric Forklift	57

Multi Tier Storage Systems can be configured from either Heavy Duty Pallet Storage Systems capped with Decking Panels (MTPSS) for heavy loads or from Universal Storage Systems components for lighter loads per level (MTUSS).

## Multi-Tier Universal Storage Systems:



# OUR INSTALLATIONS



# DRIVE-IN SYSTEM

This type of storage is chosen for pressure sensitive goods or unstable storage units which are stored in big quantities. The range of products stored in this system is small to medium-sized and has a low picking frequency. This storage solution is ideal for a small pallet turnover and favours an employment as seasonal store.

**General Advantages :**

- Compact Storage according to the First In - Last Out principle
- No pressure damage
- Safe storage of pallets with unstable loads .
- High volume utilization due to compact storage
- Optimum volume utilization
- Saves floor space
- Very economic pallet storage systems

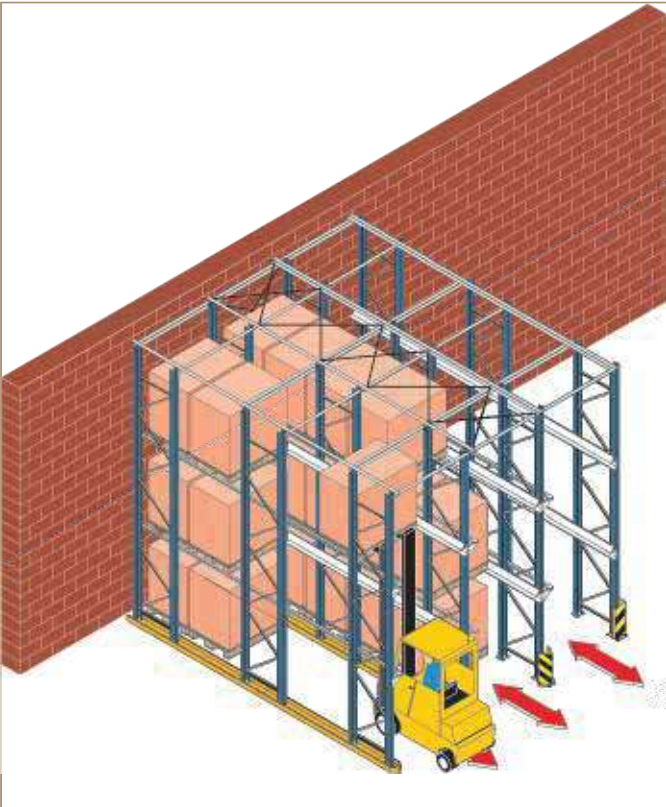

**Compatible MHE :**

Equipment	Refer to Page No.
Hydraulic Pallet Truck	49
Electric Stacker	50
Electric Reach Truck	51
Electric Forklift	57
Combilift Forklift	62

**Pillar Supported Mezzanines :**

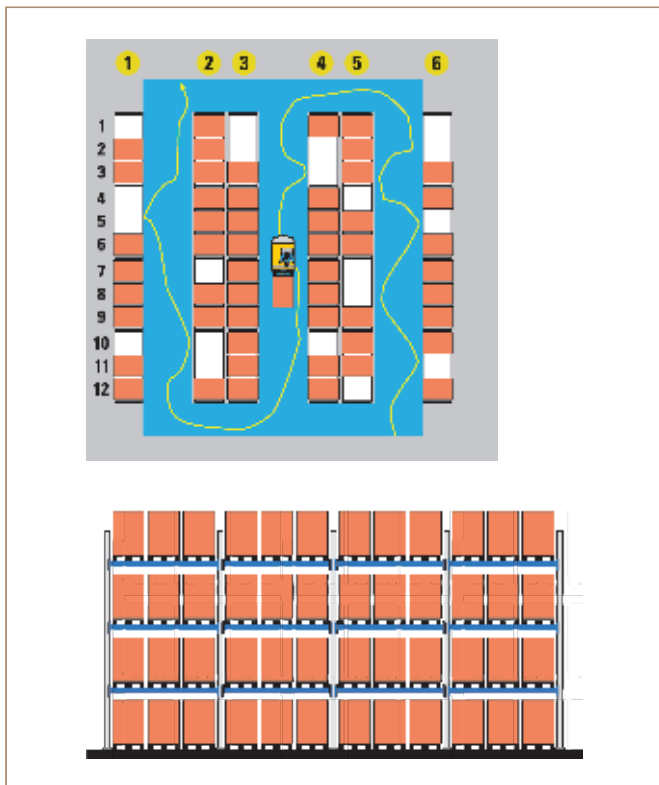

**Drive-In Pallet Storage Systems :**

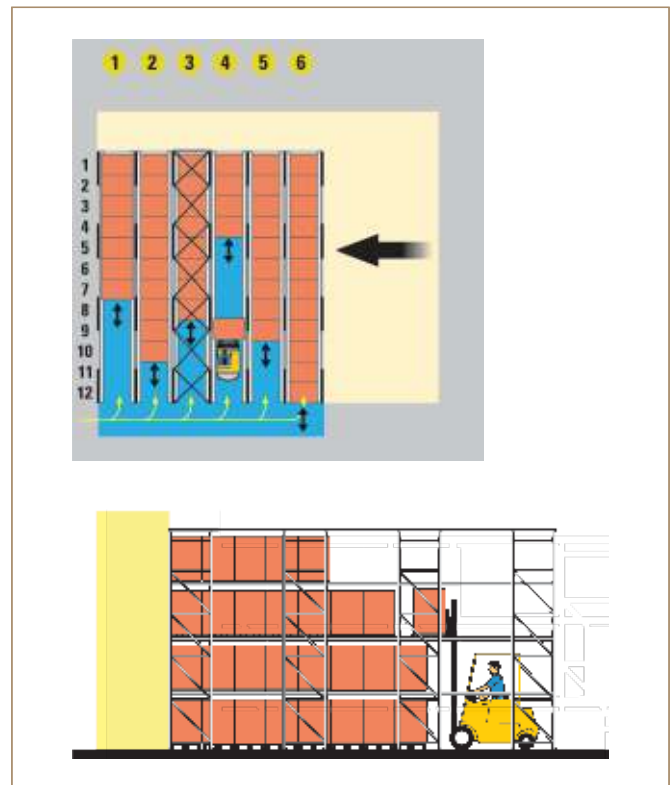

## OUR INSTALLATIONS



# AUTOMATED STORAGE & RETRIEVAL SYSTEM (ASRS)

Practical storage systems for the growing Indian Industry : Optimizing space efficiency, adaptability and accessibility to all stored items. Systems for warehouses, in-process goods and shop floor. Designing specific solutions tailored to customers needs is our forte; perfection is our passion!

**Advantages :**

- Quick and easy to assemble, mount & cost-effective installation
- Economical in long run
- Also ideal as storage for archives
- More storage capacity on less floor space
- Increased load capacity due to corner plates
- Direct access to all references
- Very good overview due to clear product presentation
- Can be integrated into almost any storage environment
- Platforms can be conveniently re-adjusted on a 25 mm pitch
- Extension bays can be added whenever required



**Compatible MHE :**

Equipment	Refer to Page No.
Electric Stacker	50
Electric Reach Truck	51
Electric Forklift	57
Aisle Master	60

# OUR INSTALLATIONS



# CANTILEVER STORAGE SYSTEM

- Salient Features :
- Also suitable for vertical storage
  - Tubular arms for coils and vertically stored goods
  - Straight arms with decking levels for flexible long loads & bulky goods.
  - Inclined platform levels with decking for ergonomic order picking of bins & containers filled with small part & components.

**Cantilever Storage Systems** are designed for single or double sided use, cantilever storage systems are ideal for long loads.



**Single sided use**



**Double sided use**

### Compatible MHE :

Equipment	Electric Stacker	Electric Reach Truck	Electric Forklift	Combilift Forklift
Refer to page no.	50	51	57	62

# OUR INSTALLATIONS



# PALLET MOVER SYSTEM

## Simple principle for maximum efficiency :

The pallet mover system consists of an automatic shuttle able to move within the drive-in channels offering a high density automated storage. Controlled by an interactive radio transmitter, the pallet mover is able to load, unload and arrange pallets into the drive-in channels. Moved by a fork lift, pallet mover operates in every channel according to the FIFO (First in First out) and LIFO (Last in First out) procedures. A forklift picks up the pallet mover unit, and places it into the center channel of the chosen rack. Thereafter, the forklift places incoming pallet loads on the pallet mover. While the forklift picks up the next pallet to be stored, the pallet mover transports the pallet quickly to its designated storage location within the rack. A wireless remote controls the movement of the pallet mover. The best use for pallet mover is in Cold Storage of food industry where temperatures can reach down to -30°. In such an environment, storage systems have to maximise the number of pallets, feature few aisles so to optimize the ratio benefit/costs. While a pallet mover solution in itself is not a new concept the key differentiator is Nilkamal Storage Systems which brings both specific local and international experience and expertise to work for you.

## Main advantages of AUTOSAT® :

- Efficient system of compact storage for warehouses with low levels of SKU
- Optimising of storage, loading and unloading stages
- Low level of risks or stress to the warehouse operating staff
- Low level of risks or damage to the equipment -loading machinery and racks, thanks to the movement front warehouse

## Specific advantages of AUTOSAT® :

- Below Zero BZ mode for environment at low temperatures -down to -30°
- Different models to meet different pallets dimensions
- Setting of gap between pallets through the remote control
- Maximum capacity 1.500 Kg
- Interactive remote control with wave capacity 150 m in open field
- Ion Lithium battery without memory effect

## FIRST IN FIRST OUT (FIFO) :

Storage method utilized in the food and pharmaceutical industries due to a precise management of expiry dates. It favors the picking of pallets containing goods produced earlier, hence stored as first. Autosat cooperates in this function allowing storage from one front and picking from the opposite of the racking system. It is necessary therefore, the two fronts of the racks to be free to allow storage and picking.

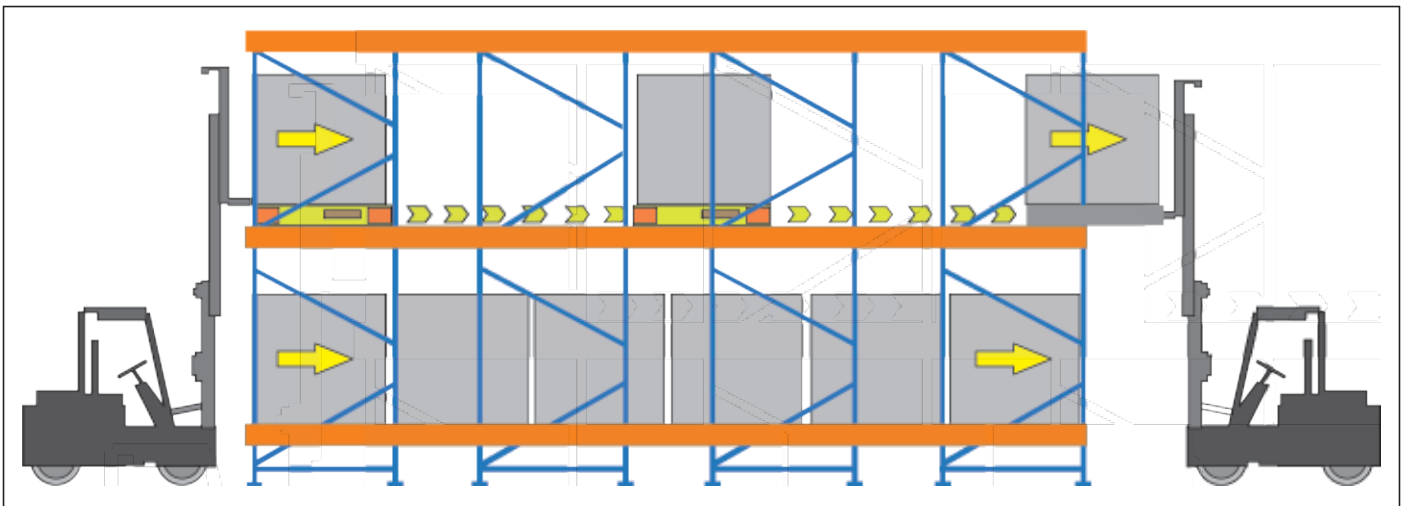

## LAST IN FIRST OUT (LIFO) :

Storage method utilized in the food and pharmaceutical industries due to a precise management of expiry dates. It favors the picking of pallets containing goods produced earlier, hence stored as first. Autosat cooperates in this function allowing storage from one front and picking from the opposite of the racking system. It is necessary therefore, the two fronts of the racks to be free to allow storage and picking.

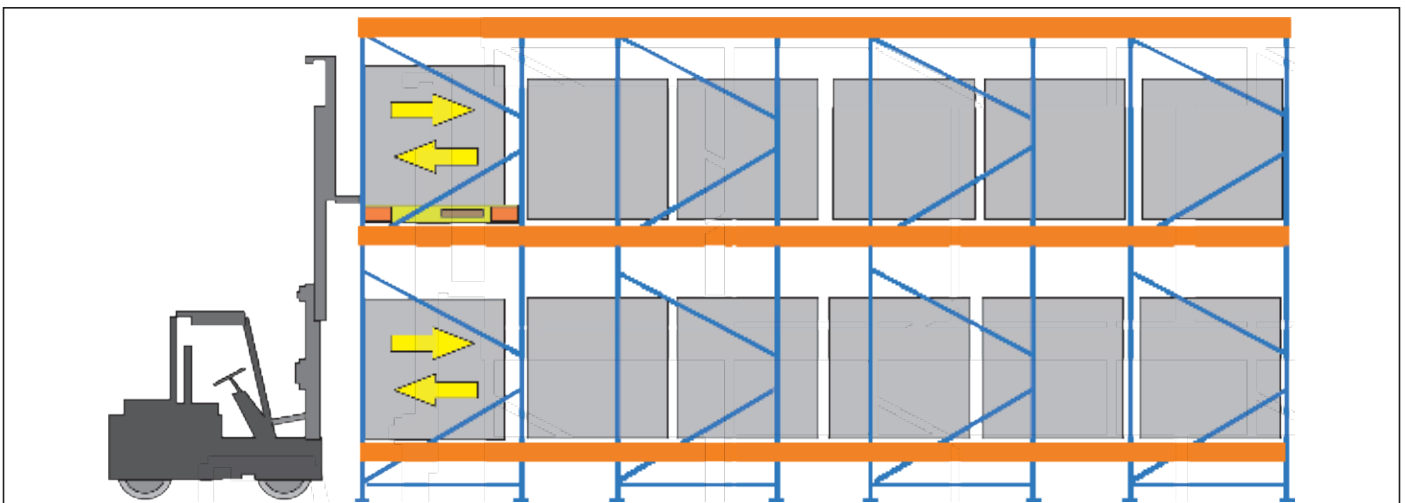

# OUR INSTALLATIONS



# KANBAN SYSTEM :

**Available Sizes (With 5 levels) :**

- 1,000 (W) x 800 (D) x 1,300 (H) mm
- 1,400 (W) x 800 (D) x 1,300 (H) mm

**Types :**

- Both sides inclined | One side inclined
- Accessories provided :
- Front stoppers on all levels
- 4 Nylon wheels per unit (Rubber or metal wheels can be provided on request)

**Applications :**

A Kanban storage unit is ideally used for smaller and lighter parts needed frequently. It is mostly used near production or assembly areas.

**Salient Features :**

- Flexible and mobile storage system for small and medium sized light weight parts
- Galvanized platforms ensure a longer rust free life
- Each level has a load carrying capacity of 150 kg UDL with a bay load of maximum 750 kg
- Sturdy construction of the trolley base stabilizes the entire unit
- High quality wheels ensure smooth and trouble free movement





# HÄNEL AUTOMATED VERTICAL STORAGE AND RETRIEVAL SYSTEMS FROM NILKAMAL



## The Hanel Leanlift®, RotoMat® and LockoMat® :

Hanel automated vertical storage & retrieval systems save your space & time as against conventional storage systems & time to retrieve your goods.

- Save your occupied floor space
- Saves time in retrieval
- Ergonomic retrieval, No bending, stretching or climbing ladders
- Protect your goods from damage & theft
- Compatible with your IT systems, giving you up to the minute reports of stored goods right at your desk
- Backed by Nilkamal's after sales service.



**Leanlift** - Ultimate storage system



**RotoMat Industrial** - Optimize material handling



**RotoMat Office** - Efficient files retrieval, frees costly office space



**LockoMat** - Ideal for costly products and data

# HÄNEL LEAN-LIFT®

The Hänel Leanlift is both storage rationalization and goods protection in one : At the center of the cabinet is a computer-controlled positioning lift - called the 'extractor'. In front of it and behind it are the storage shelves. This is where the articles are kept in containers. The storage locations are accessed automatically under electronic control by means of the extractor, which stores or retrieves the requested container. The goods are then delivered to the retrieval area at the correct ergonomic height.

## Schematic Drawing :



With the Hänel Lean-Lift® we offer you a first-class, high-tech system for storage organization and materials handling that saves time, storage space and costs, and enables a much more efficient workflow.

### **OVER 60 % MORE SPACE :**

The Hänel Lean-Lift® uses the available room height and stores parts in height-optimized positions so that no space is lost. This produces maximum storage capacity on a minimal footprint. This in turn saves costs and helps to utilize the area dedicated to storage more economically.

### **WORK TIME SLASHED :**

The Hänel Lean-Lift® brings the requested item automatically to the access area in seconds, where it can be retrieved at the optimum ergonomic height. Goods to man is the motto instead of man to goods. Access times are radically reduced and order-picking performance substantially improved.

### **THE RIGHT DECISION :**

If you want to improve your intralogistics and reduce costs, you should talk to our product specialists first. They will work with you to develop your own 'tailor-made intralogistics concept'.



# HÄNEL AUTOMATED VERTICAL STORAGE AND RETRIEVAL SYSTEMS FROM NILKAMAL



## Distinct advantages over conventional rack storage!

- Advantages :**
- Over 60% more storage capacity over conventional racks
  - Optimum storage of highly varied parts without any loss of space
  - Storage capacity can be adapted step by step
  - More than one person at a time can operate the lift and process jobs
  - Retrieval times reduced
  - Units can be added, expanded or separated later
  - Better utilization of storage volume due to height-optimized storage
  - Decentralized storage right in the production hall.

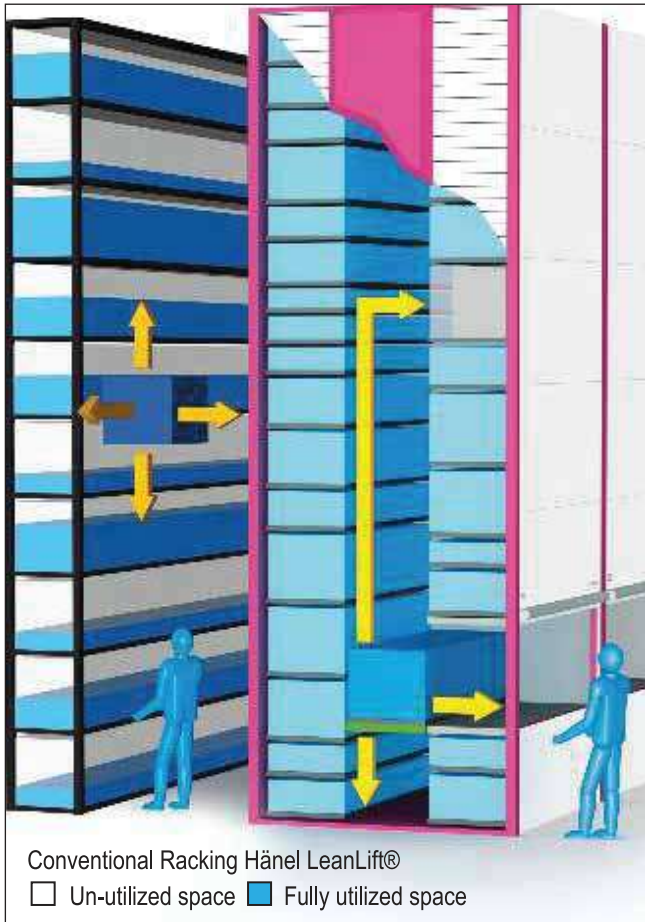

**Accurate height measurement** for storing containers in the optimal packing density.

Height-measuring light barriers spaced at 25 mm, 37.5 mm, 75 mm, 90 mm or 125 mm. When the container is drawn in, the highly accurate light barriers measure the articles, and the Hänel microprocessor control system finds the optimum



storage location in the Hänel Lean-Lift®.

At the same time a protruding goods check is carried out. With its height sensors, profile wall and Hänel container technology, the Hänel Lean-Lift® provides vertical optimization and height optimization in one!

**Weigh each container accurately** The Hänel Lean-Lift® can be equipped with an optional electronic 4-point weighing system to weigh each container in the access point without any loss of time. The current weight is then shown on the keyboard display. The weighing device allows the maximum load of the individual containers and that of the entire lift to be recorded. The additional



payload is determined with the tare function. Container weight accurately ascertained in the access point with no loss of time thanks to the electronic weighing device

### The multi-purpose fold-down support rail



The support rail at the access point can be raised and folded down as required. Storage containers can then be pulled out of the access point on smooth running plastic rollers. This makes work at the Hänel Lean-Lift® even more ergonomic. Heavy parts can



also be removed with a crane. By aligning a heavy duty trolley, complete containers can be taken out of the Lean-Lift®, with the fold-down support rail. This means that even with particularly heavy parts (up to 1,000 kg per container) the container can be moved easily to the required destination. The Hänel Lean-Lift® can also handle bulky goods like Euro Pallets, engine blocks etc.

### The Hänel Multi Function Container



The Hänel Multifunction containers can be customized to handle highly diverse storage articles make highly diverse demands on the container. The containers are configured according to the weight and size of the goods handled, making each Hänel LeanLift unique. Hänel Multi-function containers are distortion free for smooth operation.





# HÄNEL AUTOMATED VERTICAL STORAGE AND RETRIEVAL SYSTEMS FROM NILKAMAL

## THE HÄNEL ROTOMAT

The Hänel Rotomat® creates an enormous amount of storage space on a small footprint. It works on the Ferris wheel principle, i. e. the archives come to the operator, not the operator to the archives. The space created on the footprint can be up to 60% more than using a conventional storage system.



RotoMat Operating Principle

**The Hänel Rotomat® Industrial Carousel** increases your storage efficiency, speeds up access times and facilitates ergonomic material handling. The extra storage capacity generated means a tremendous cost saving for you!



**The Hänel Rotomat® Office Carousel** filing and records management system makes use of the room height, so its compact design creates more filing capacity. This means expensive office space is freed for more efficient use.



Hanging Folder and files



Vertical Folder and files



Box files

# COLD CHAIN PRODUCTS

The Cold Chain industry in India has taken a giant leap forward and Nilkamal is all set to benefit from this latest Industrial Revolution. We have provided diverse storage systems for various kinds of storage applications for many marine food and shrimp processors as well as for vegetable, fruit and food storage companies. For retail and Clean Room needs, we offer Camshelving® which is a CKD and completely adjustable storage system that has the strength of Stainless Steel without its disadvantages. For transport and storage at the retail level, we have a range of Insulated Ice Boxes and Insulated Fish Tubs that have proven their mettle for demanding customers under stressful conditions not only in India but also across the world.



Multi Tier Racking System For Cold Storage



Ice Boxes



Fish Tubs

# ICE BOXES

Innovatively designed with latest technology made from food grade virgin USDA / FDA / EU approved polyethylene PU filled and UV stabilized for keeping hot items hot old items cold.



WT : Without Tap & Vending Lid



WTVL : Without Tap & With Vending Lid



With Tap & Without Vending Lid



With Drain Cap & Without Vending Lid



VL : With Tap / Drain Cap & Vending Lid



DVL : With Dual Vending Lid



Economy Insulated Ice Box



Blow Molded Ice Box

NEWLY DEVELOPED



(Vending Cover Lid)



(Plain Lid)

Pvc In-built Hinge Rod Design

**Salient Features :** Capacities Available from 20 Litres to 250 Litres (More than 60 models) With & Without Tap / Drain Cap & With & Without Vending Lid

- Manufactured from USDA / FDA / EU approved food grade polyethylene. • PU filled & UV stabilized. • Excellent insulation maintains uniform temperature for storage & transportation of frozen food, fish, meat, confectionaries, ice cream, fruits & vegetables, chilled beverages, dairy products & pharmaceutical products. • Hygienic, easy to clean & wash. Strong & durable. Ensures freshness of contents over a long duration.
- Stackable for space saving. • Used for storing chilled soft drinks, perishable items, snacks, pastries & frozen foods. • All the ice boxes are available with & without drain cap / tap & vending lid • Model 100 & 150 ltrs. capacity ice boxes have integral hinges. • 150 ltrs. is available with normal / single / dual / vending lid.

MODEL NO.	DIMENSIONS (L X B X H) in MM. approx.	
	Outer	Inner
RIC10LTRWTIP	374 X 255 X 206	328 X 201 X 152
RIC10LTRWTWIP	374 X 255 X 206	328 X 201 X 152
RICE20LTRWT	410 X 290 X 320	320 X 250 X 255
RIC25LTR	500 X 335 X 303	390 X 282 X 252
RICE35LTRWT	542 X 452 X 239	500 X 410 X 182
RIC50LTR	645 X 405 X 420	520 X 350 X 340
BIC50LTRVL	645 X 390 X 385	570 X 315 X 300
BIC50LWTVLN	620 X 355 X 360	578 X 310 X 305
BIC50LWTN	620 X 355 X 360	578 X 310 X 305
RICE50LTR	605 X 390 X 330	510 X 350 X 285
RIC50LA	645 X 405 X 425	520 X 340 X 340
RIC50LWTA	645 X 405 X 425	520 X 340 X 340
RIC50LVLA	645 X 405 X 425	520 X 340 X 340
RIC50LWTVLA	645 X 405 X 425	520 X 340 X 340
RIC60LTR	625 X 425 X 415	515 X 360 X 330
RIC70LTR	750 X 530 X 430	650 X 430 X 305
RICE70LTROCT	750 X 480 X 380	683 X 415 X 290
RICE100LTROCT	812 X 533 X 430	743 X 464 X 330
RIC100LTR	750 X 530 X 520	650 X 430 X 390
RIC110LTR	755 X 535 X 560	655 X 435 X 392
RIC120LTR	610 X 610 X 650	510 X 510 X 500
RIC150LTR	840 X 575 X 745	680 X 450 X 600
RIC220LTR	1050 X 640 X 750	890 X 520 X 600
RIC250LTR	1015 X 700 X 758	875 X 508 X 615



RIC10LTRWTIP



**Abbreviations :** RIC : Roto Insulated Crate BIC : Blow Molded Insulated Crate WT : Without Tap / Drain Cap VL : Vending Lid E : Economy OCT : Octagonal LTR : Litres  
IP : Ice Packs WIP : Without Ice Packs

# FISH TUBS

Innovatively designed with latest technology made from food grade virgin USDA / FDA / EU approved polyethylene PU filled and UV stabilized. Mainly used for storing marine products at the ports. All the below mentioned insulated fish tubs are available with & without lids

## ROTO MOULDED INSULATED FISH TUBS :



**Model : RIFT1000**  
CAPACITY : **1000 LITRES**  
(Other capacities available :  
**310 / 460 / 660 litres**)

## ROTO MOULDED INSULATED FISH TUBS (NW) :



**Model : RIFT660NW**  
CAPACITY : **660 LITRES**

## NEW GENERATION INSULATED FISH TUBS :



**Model : RIFTE1000**  
CAPACITY : **1000 LITRES**  
(Other capacities available :  
**400 / 600 litres**)

## CUBE INSULATED FISH TUBS :



**Model : RIFT35**  
CAPACITY : **1000 LITRES**  
(Other capacity available : **700 litres**)

## ROTO MOULDED INSULATED FISH TUBS

MODEL NO.	OUTSIDE DIMENSIONS (L X B X H) approx. in MM.	INSIDE DIMENSIONS (L X B X H) approx. in MM.	HEIGHT OF TUB WITH LID
<b>RIFT310</b>	915 X 715 X 710	865 X 665 X 575	765 MM.
<b>RIFT460</b>	1230 X 1030 X 580	1165 X 965 X 430	650 MM.
<b>RIFT660</b>	1230 X 1030 X 750	1165 X 965 X 600	820 MM.
<b>RIFTNW660</b>	1235 X 1035 X 750	1167 X 967 X 600	820 MM.
<b>RIFT1000</b>	1470 X 1180 X 890	1390 X 1100 X 725	965 MM.

## TRACKING SOLUTIONS :

**RFID** : Equipped with Radio Frequency Identification (RFID) Tags to ensure that each tub is tracked & managed properly

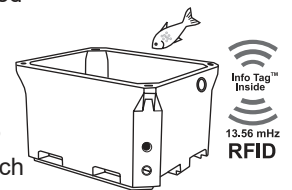

## NEW GENERATION INSULATED FISH TUBS :

MODEL NO.	OUTSIDE DIMENSIONS (L X B X H) approx. in MM.	INSIDE DIMENSIONS (L X B X H) approx. in MM.	HEIGHT OF TUB WITH LID
<b>RIFTE400</b>	1200 X 1000 X 570	1135 X 935 X 380	640 MM.
<b>RIFTE600</b>	1200 X 1000 X 750	1135 X 935 X 560	820 MM.
<b>RIFTE1000</b>	1470 X 1170 X 880	1385 X 1085 X 665	960 MM.

## BARCODE :

The barcode contains machine readable data and is used in warehouses for stock assessment



## CUBE INSULATED FISH TUBS :

MODEL NO.	OUTSIDE DIMENSIONS (L X B X H) approx. in MM.	INSIDE DIMENSIONS (L X B X H) approx. in MM.	HEIGHT OF TUB WITH LID
<b>RIFT25</b>	1220 X 1085 X 890	1105 X 965 X 695	965 MM.
<b>RIFT35</b>	1220 X 1085 X 1205	1105 X 965 X 1005	1275 MM.

## QR-CODE :

QR code placed on each tub can be programmed to contain data such as company address, website & contact details.



Abbreviations : RIFT : Roto Insulated Fish Tub • E : New Generation • NW : New Version

# COLD CHAIN PRODUCTS

## RACKING SYSTEMS FOR COLD STORAGE :

Nilkamal offers state of the art storage system for various applications such as seafood storage, fresh produce, fruits etc. We are an ISO 9001:2008 Organization having the latest manufacturing systems imported from Europe. With a spectrum of customers spanning India, we are at your service to offer you a comprehensive storage and handling solution.

## MULTI TIER RACKING SYSTEM FOR COLD STORAGE :



## SHELVING :

With 3 Distinct Lines of shelvings, all kitchens are created equal. Every food service operation deserves to be set up for maximized cost savings, space efficiency, sanitation, food safety & functionality no matter what the size or budget. Shelving storage systems make it all possible, helping food service operators optimize organization, support food safety, improve labor savings, simplify inventory management, reduce food waste and eliminate replacement costs.



# FOOD SERVICE PRODUCTS

Satisfaction is equal to motivation ! A satisfied workforce is a motivated workforce, and nothing brings satisfaction everyday than a good hot meal served in the company cafeteria. Use Cambro Nilkamal Ultra Pan Carriers (UPC) to keep food hot during transport from base kitchen to company cafeteria. Compartment trays for efficient food dispensing, and Cambro Nilkamal LCDs for serving tea and coffee. Upgrade to Cambro Nilkamal's food service products today! Cambro Nilkamal Pvt Ltd is Nilkamal's manufacturing and marketing JV with Cambro Mfg Co, USA, world leader in food service and storage products with a range of over 14000 items preferred by top end hotels and health conscious organizations worldwide.



Compartment Trays



Ultra Pan Carriers to keep food hot during transport



Insulated Beverage Containers for Tea / Coffee

# FOOD SERVICE PRODUCTS

## ULTRA PAN CARRIERS : UPC400 - Keep food hot for 4 hours !

Keep your food steaming hot while it is being transported from base kitchen to your cafeteria premises. You can carry the items separately - rice, rotis & curry in spill proof Cambro GN pans fitted with GripLids or pre-packed Cambro Nilkamal Compartment Trays designed to fit 2 in a row per level in a UPC400. Ensure workforce satisfaction with a great hot meal..!!



Cambro GN Pan with GripLid®



Loading in UPC400



Pre-packed trays in UPC400



UPC400 being loaded in vehicle

## MAKE YOUR FOOD LOOK GOOD !

Ensure staff satisfaction with a well laid out plate - Cambro Nilkamal's compartment trays, meal trays and fast food trays. Complemented by Cambro Nilkamal's virtually unbreakable poly carbonate glasses, tumblers, pitchers as well as bowls and mugs for soups and side dishes.



Colorful compartment trays



Food trays (Small) with dishes & bowls



Food trays (Big) with dishes & bowls



Glasses & Pitchers



Compartment Trays being readied for service

## TAKE CARE OF TEA / COFFEE BREAKS WITH THE 500LCD CANTAINER !

- Use to hold, transport and serve hot or cold beverages for up to 4 hours
- One piece, seamless double-wall polyethylene with thick foam insulation
- Sturdy rust proof plastic latches secure lids tightly
- Equipped with a recessed spigot for easy self-serve access
- Stackable for minimized storage space
- Stack interlocking ensures stable stacking during transport and storage
- The universal favourite of caterers



# FOOD SERVICE PRODUCTS

## INCREASE TABLE SERVICE EFFICIENCY :

Organize dishes, plates, cups & mugs, glasses, cutlery with Cambro ware washing products and service carts. In addition to enhancing the efficiency of food service, these products also provide safety to these fragile products during handling & automated washing operations.



Cup rack



Glass rack



Plates rack



Flatware rack for cutlery

## DO YOU WANT AN ON-SITE KITCHEN.?

Upgrade to the best latest International standards of food storage with Cambro Food Storage Products. Ingredient Bins with scoops. Rust free and easily cleaned elements are for storage of food ingredients, air tight food boxes etc.



Elements



Ingredient bins



CamSquare airtight food boxes

# HOSPITALITY PRODUCTS

Provide better table service with the KD Service Carts & Dish Caddies !

## KD SERVICE CARTS :

Versatile body, durable and economically-priced utility cart with rails and shelves to keep contents in place. Additional shelves can be added as an option.



## ADJUSTABLE DISH CADDIES :

Adjustable towers to set up 4 or 6 columns of dishes. Can hold up to 45-60 plates. Store one size dish or a combination of different sizes in a single caddy



## CLEAN & HYGIENE BINS FOR KITCHENS & CANTEENS :

International quality products for systematic waste management in the kitchen and canteen area



Color coded pedal bins for hygienic waste segregation



Color coded wheeled bins for waste segregation



Color coded wheeled bins for waste segregation

# HOSPITALITY INDUSTRY

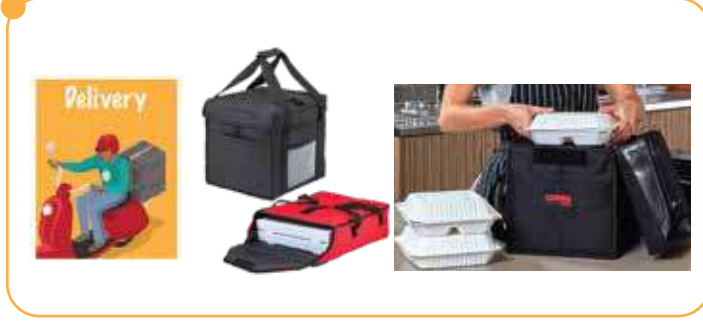

## Food Preparation Equipment

**dipo** INDUCTION  
global leader of induction solution

South Korea



TCK26/35

Tabletop & Warmers

**Electrolux**

Italy



S Double ski

Undercounter Glass & Dishwashers

**Hamilton Beach**  
COMMERCIAL

USA



HBB908R-CE

High performance blenders

**robot coupe**

France



CL 50

Vegetable preparation Machine

**SIRMAN**

Italy



PPJ 20

Potato peelers - mussels cleaner

# FROM ANYWHERE TO EVERYWHERE

## SEEKING OUT THE BEST OFFERINGS

### FROM ACROSS THE GLOBE, ENSURING QUALITY AND AFFORDABILITY

Authorized Dealer for



#### Also carrying stocks of



Round & Square Insulated Container



Fiber and PP Anit-Skid Trays



SS GN Pans of Grade 201 & 304



6/4 Slice Bread Toaster



Deep Fryer



Griddle



Popcorn Machine

And many more product...



# PRIMARY RIGID PACKAGING PRODUCT

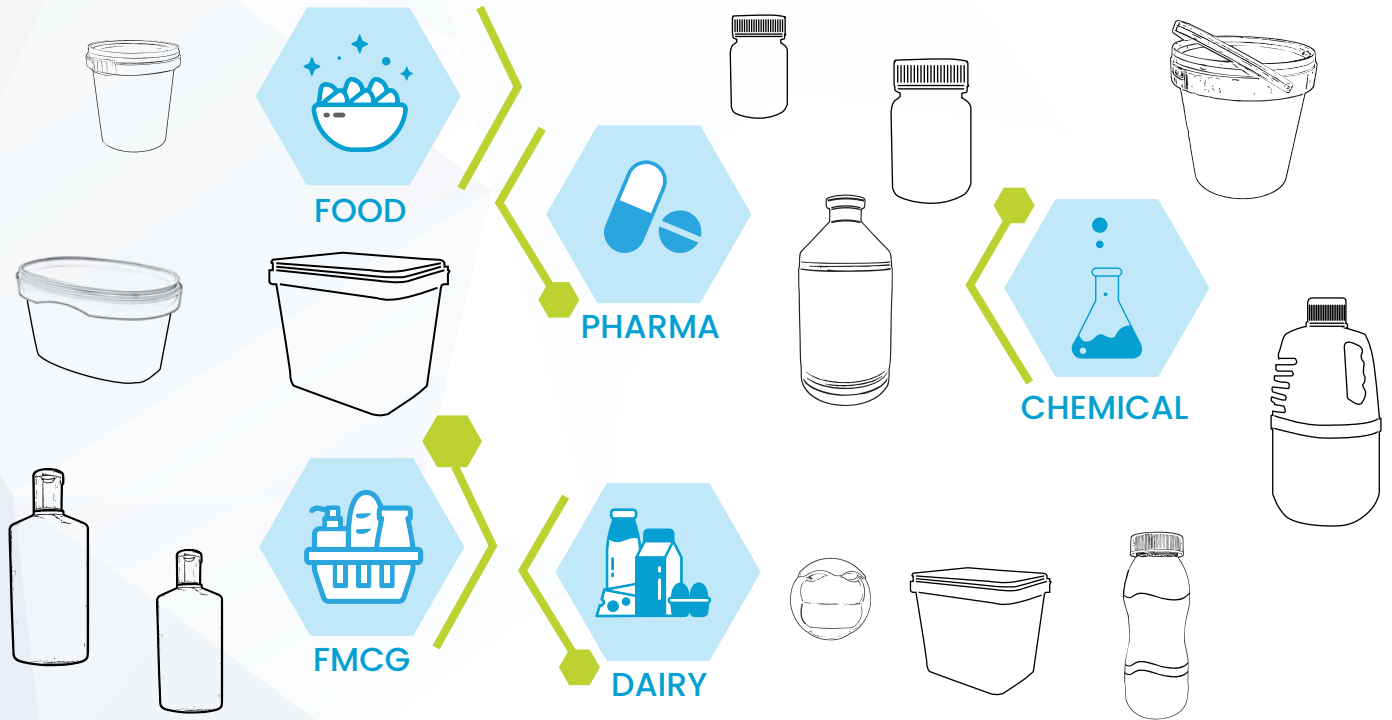

## PRODUCTS



Press Fit Lid, Tamper Evidence, Reusable, Stackable & Nestable

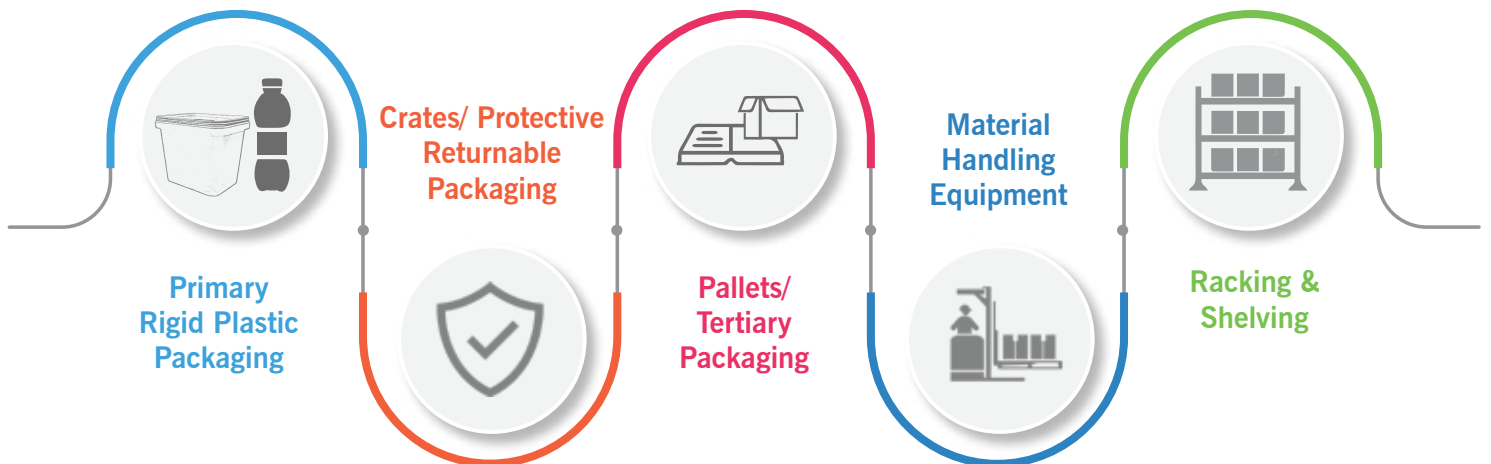

With the introduction of **Rigid Packaging**, we are positioned strongly as a one-stop solution provider in the material handling and rigid packaging space.

[www.nilkamalpackaging.com](http://www.nilkamalpackaging.com)

# WASTE MANAGEMENT PRODUCTS

Nilkamal offers industry standard, state-of-the-art Waste Bins which are widely used by Industries, Municipalities, Airports, Co-operative Housing Societies, Parks, Commercial and Residential Complexes, Hotels and Restaurants etc. Salient Features : • Environmental Friendly • Long Lasting • Easy to use & maintain • Safeguards public health • Prevent diseases, safe for workers • Resistant to UV radiation



**WASTE BINS** - Used in soot disposal



Color Coded Wheeled Bins



Color Coded Free Stand Bins

# ROUND CONTAINER



Model	Dimensions
RC80L1WH	530X530X660MM
RC80L1HWWH	530X530X660MM
RC80L2WH	525X525X780MM
RC80L2HWWH	525X525X780MM



Model : **DB12LCANESRB**  
Dimensions : 32.3(W) x 28.3(D) x 33.9(H) MM



Model : **TDB10LPGR/BLU/IBK**  
Dimensions : 285(L) X 305(W) X 410(H) MM  
(Available in single color option)



# FREE STAND LITTER BINS



Model : **RFLB60L1**  
Capacity : 60 litres approx.



Model : **RFLB80L1**  
Capacity : 80 litres approx.



Model : **RFLB100L1**  
Capacity : 100 litres approx.



Model : **RFLB100L2SWNLID**  
Capacity : 100 litres approx.



Dual Pole Mounted Version

Model : **RFLB50L2** • Capacity : 50 litres approx



Dual Pole Mounted Version

Model : **RFLB150L1** • Capacity : 150 litres approx.



Industrial Application



Color Coded Waste Segregation as per industrial practice

**Abbreviations : RFLB : Roto Molded Free Stand Litter Bin • SWN : Swinging Lid • L : Litres**

# FREE STAND LITTER BINS

Used for waste collection for factories, offices and complexes.



Model : **RWB90L1**  
Capacity : 90 litres approx.



Model : **RWB120L1**  
Capacity : 120 litres approx.



Model : **RWB240L1**  
Capacity : 240 litres approx.



Foot Pedal Available (Optional)

# COMMUNITY WASTE COLLECTION TOOLS

COMPACTOR COMPATIBLE WHEELED BINS



Model : **WB120L1**  
Capacity : 120 litres approx.



Model : **WB240L1**  
Capacity : 240 litres approx.



Model : **WB360L1**  
Capacity : 360 litres approx.



Foot Pedal Available (Optional)



Model : **WB660L1**  
Capacity : 660 litres approx.



Model : **WB1100L1**  
Capacity : 1100 litres approx.



Community Application Of Compactor Compatible Bins

**Abbreviations : RWB : Roto Molded Wheeled Bins • WB : Wheeled Bins • L : Litres**

# STREET COLLECTION



Model : **CC33325WH**



Model : **CC33375WH**



Model : **RCSQ40L**



Model : **RCSQ50L**



Model : **CC33460**



Model : **CC33460WH**



Model : **LID33460**  
Dimension: 365 (L) x 365 (W) x 25 (H)



Model : **RCRECT65L**



Model : **RCRECT110L**



Model : **RCRECT150L1**



Model : **RCRECT240L1**



Model : **RCRECT255L**

Model	Top (mm)	Bottom (mm)	Height (mm)
CC33325WH	325 X 325	290 X 290	335
CC33375WH	330 X 330	300 X 290	375
RCSQ40L	350 X 350	285 X 285	455
RCSQ50L	420 X 420	390 X 390	340
CC33460	355 X 355	285 X 285	460
CC33460WH	355 X 355	285 X 285	460
RCRECT65L	530 X 530	460 X 460	280
RCRECT110L	750 X 730	450 X 430	360
RCRECT150L1	1000 X 710	570 X 565	385
RCRECT240L1	1000 X 705	575 X 565	550
RCRECT225L	1135 X 870	750 X 480	450

# ROAD SAFETY PRODUCTS

Welcome to the Road Safety Products from Nilkamal Limited, India's No 1 Organization in Material Handling. These uniquely designed and well engineered barriers, barricades and other traffic movement regulation products facilitate easy handling and are also easy to install or fit. They are manufactured from premium grade UV stabilized virgin polyethylene material. Designed to interlock easily, Nilkamal barricades can readily form a wall. The barriers have been designed to withstand high wind pressure generated by fast moving vehicles and are also more effective, more stable and safer compared to conventional products such as drums, posts and such like used to form temporary barricades. Strips of retro-reflective sheets are also pasted on the barriers to enhance visibility during night.

## PERFORATED BARRICADE FENCES :



Model : **RMBPF20041000**  
 Outside Dimensions : **2020 (L) x 400 (W) x 1265 (H) mm. approx.**  
 Available Colors : **Red & Yellow**



Model : **RMBPF21041000**  
 Outside Dimensions : **2160 (L) x 400 (W) x 1250 (H) mm. approx.**  
 Available Colors : **Red & Yellow**



Model : **RMRBDE1003620**  
 Outside Dimensions :  
**1140 (L) x 275 (W) x 620 (H) mm. approx.**  
 Available Colors : **Red & Yellow**



Model : **RMRBDG10035760**  
 Outside Dimensions :  
**1000 (L) x 350 (W) x 760 (H) mm. approx.**  
 Available Colors : **Red & Yellow**



Model : **RMRBDF1003855**  
 Outside Dimensions :  
**1060 (L) x 350 (W) x 855 (H) mm. approx.**  
 Available Colors : **Red & Yellow**



Model : **RMRBDC1004400**  
 Outside Dimensions :  
**1125 (L) x 400 (W) x 400 (H) mm. approx.**  
 Available Colors : **Red**



Model : **RMRBDB1306850**  
 Outside Dimensions :  
**1325 (L) x 600 (W) x 850 (H) mm. approx.**  
 Available Colors : **Red & Yellow**



Model : **RMRBDD15041000**  
 Outside Dimensions :  
**1640 (L) x 400 (W) x 1000 (H) mm. approx.**  
 Available Colors : **Red & Yellow**

# ROAD SAFETY PRODUCTS

## SAFETY BARRICADES (INTERLOCKING & WATER FILLABLE) :



Model : **RMRBDA2160840**  
 Outside Dimensions :  
**2100 (L) x 600 (W) x 840 (H) mm. approx.**  
 Available Colors : **Red & Yellow**



Model : **RMRBDI1246790**  
 Outside Dimensions :  
**1260 (L) x 455 (W) x 795 (H) mm. approx.**  
 Available Colors : **Red & Yellow**



Model : **RMRBDA21601000**  
 Outside Dimensions :  
**2100 (L) x 600 (W) x 1000 (H) mm. approx.**  
 Available Colors : **Red & Yellow**



Model : **RMRBDM17041000**  
 Outside Dimensions :  
**1700(L) x 400(W) x 1000(H) mm. approx.**  
 Available Colors : **Red & Yellow**



Model : **RMRF18441900**  
 Outside Dimensions : **1850 (L) x 440 (W) x 1885 (H)**  
 Available Color : **Black**

## HEXAGONAL SAFETY CONES :



**HEXAGONAL SAFETY CONE (SMALL) :**  
 Models : **RMHEXDC750**  
**RMHEXDC750HW (Heavy Weight)**  
 Outside Dimensions :  
**420 (L) x 370 (W) x 750 (H) mm. approx.**  
 Available Color : **Red**



**HEXAGONAL SAFETY CONE (BIG) :**  
 Models : **RMHEXDC1000**  
**RMHEXDC1000HW (Heavy Weight)**  
 Outside Dimensions :  
**420 (L) x 370 (W) x 1000 (H) mm. approx.**  
 Available Color : **Red**  
 Also Available : **HW (Heavy Weight) Models**

## ROAD LIGHT BARRIERS :



Models : **RMHLS6081275**  
 Outside Dimensions :  
**600 (L) x 80 (W) x 1275 (H) mm. approx.**  
 Available Color : **Olive Green**



Models : **RMHLS45201310**  
 Outside Dimensions :  
**450 (L) x 195 (W) x 1310 (H) mm. approx.**  
 Available Color : **Olive Green**



Head Office : Nilkamal Limited , Nilkamal House, Street No. 14, M.I.D.C., Andheri (East),  
Mumbai - 400 093, India, **Toll Free : 1800 890 9115** • Tel. : +91-22 4235 8888 / 2836 1366,  
E-mail : [marketing@nilkamal.com](mailto:marketing@nilkamal.com) • Visit us at : [www.nilkamalmaterialhandling.com](http://www.nilkamalmaterialhandling.com)



This catalogue is issued to provide outline information only & is not deemed to form part of an offer or contract. Our policy is of continuous improvement & we reserve the right to change details without prior notice.

**9 ISO Certified Factories, 40 Regional Offices & 35+ Warehouses all-over India**